



LAKES
SHOWERING SPACES

Lakes life
easier



Carbon
Neutral
Organisation

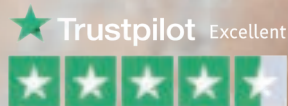

Designed for Life

Showering is more than simply washing, it's taking much needed time for yourself.

The past couple of years have taught us that we need to take our time when we can get it. For many those precious, blissful few minutes in the shower are rare opportunities in our busy days to unwind, to relax and to refresh. It's a time to think, to recharge and to prepare.

From the clarity of the glass to the quiet glide of the doors and even the reassuring feel of the tray under our feet. At Lakes, we consider every element of the showering space, to make sure it suits the needs of the people using it.

Whatever you need, whatever your style, scale or budget, our intelligent designs means there's a solution for you and your shower routine need be anything but routine.



Bev Brown
Chairman



It's all in the detail



What does quality mean to you?

Our senses of sight, sound and touch combine – often without us realising – to define quality, and the smallest of details can make the biggest difference. So we've examined every component of the showering space and how each adds to this feeling of quality.

Softly-closing doors; refined hardware; handles that feel secure and comfortable in the hand; beautiful, crystal clear, specially-treated glass that doesn't scratch. Trays that feel solid and don't wobble underfoot. Elegant designs and solutions for multi-generational living. They may not sound revolutionary, but, together, they add up to something special – a reaction that's more 'ooh' than 'okay'.

We've even engineered things you don't notice immediately, but still make a huge difference when it comes to cleaning and maintenance, such as quick-release doors and unique interlocking caps.

Lakes' quality extends beyond ergonomics and craftsmanship. Our service is simply the best in the business and our precision engineering gives us the confidence to offer a no-quibble Lifetime Guarantee that is transferable if you move house.

It's the attention to detail that really counts. Because when we get it right, you can simply get on with enjoying your showering space.



Lakes glass... for a Superior Showering experience

Glass you see straight through.

Showering spaces tend to be mostly glass, but it's the last thing you notice because the eye is drawn to the shiny fixtures and fittings. In fact, the better the glass, the less you notice it. Lakes Glass has been developed to ensure a crystal clear, smear-free shower that doesn't detract from your beautiful bathroom.

Glass to give your bathroom a clear edge.

You may not have noticed it before, but the iron-oxide content of standard glass gives it a green tinge. It's most evident when you look at the edge of the glass – and the thicker the glass, the greener it gets – but it also tints everything seen through it.

That's why we introduced PureVue^{HD} with reduced iron for dramatically clearer glass. From your carefully chosen bathroom tiling and décor to fittings and accessories, you will see a purer true-colour vision of your bathroom.

Glass that stays sparkling and clear.

Your shower is where you unwind and relax. But it's hard to relax when you're distracted by scratched glass and hard-to-clean limescale, smears or soap scum. Lakes Glass with AllClear[®] has a high-tech nano-bonded treatment on both sides of the glass which means water, limescale and soap scum slide off the glass rather than sticking to it. It stays clear and clean.

Glass with added value built in.

Quality is defined by how showering spaces perform. How they stay looking great. How they add sparkle and clarity. How they save time, energy and effort of cleaning.

Lakes Glass: a superior quality showering experience.



Experience the true colours of your showering space with PureVue^{HD} crystal clear, low iron glass.

PureVue^{HD} low iron glass reduces the green hue in standard glass to near-zero, so glass is clearer, lighter and brighter.

PureVue^{HD} is included in our Island and Coastline Collections, and selected Walk-Ins at no extra cost.

Normal glass has a green tinge

Lakes AllClear[®]

The shower is often one of the most in-demand utilities in a busy household, which can make it hard to keep clean and looking good as new. Lakes AllClear[®] advanced glass coating is applied on both sides of the glass as standard and at no extra cost.

The science behind clear glass. The microscopic nanoparticles in the Lakes AllClear[®] innovative bonded coating fills the gaps in the naturally pitted surface of the glass to ensure water, limescale and soap scum simply slides off.

A simple wipe clean with a damp cloth of the specially treated glass keeps it looking like new, so your relaxing shower isn't spoiled by smears and smudges.

Lakes Glass with AllClear[®] is 10 times more scratch resistant than standard glass, so it can handle whatever life throws at it.

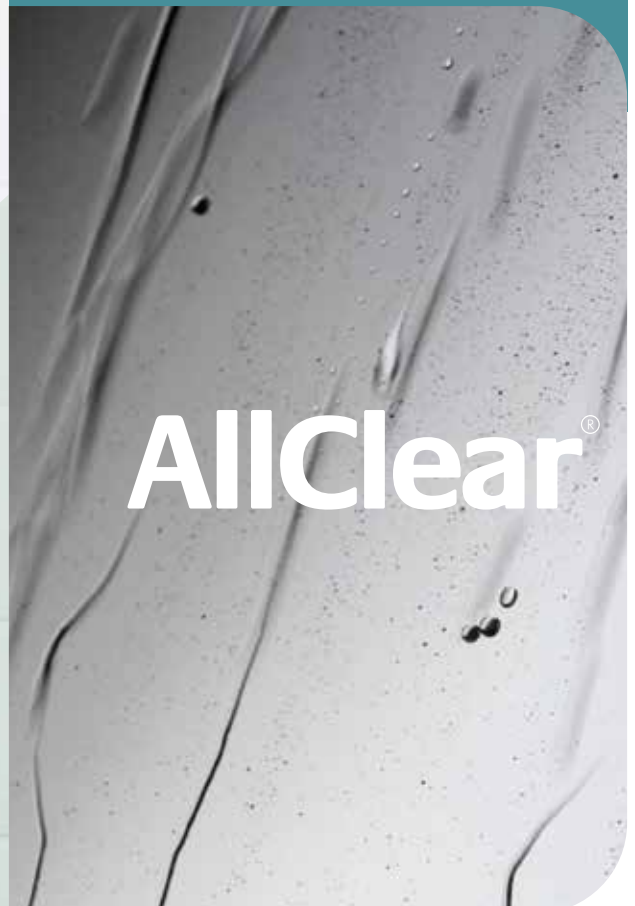



Loyal, regular customers as well as those buying a Lakes product for the first time agree our products are 'excellent'. Lakes rating published via Trust Pilot is Excellent.



We are proud members of the Bathroom Manufacturer's Association and collaborate with many other fellow companies to focus on raising quality standards, improving safety and compliance and sustainability by reducing our environmental impact – all helping shape the future growth of our industry and showering product sector.

Lifetime Guarantee

Showers are important and integral elements of our lives. So, when it comes to buying or replacing a showering space, it helps to know your choice is supported by the highest quality assurance, customer service and technical support.

Lakes' genuine Lifetime Guarantee* covers all our shower doors and enclosures and spare parts and is also fully transferable. So even if someone moves home, the new owner will still be covered for the lifetime of the product.

If you have a problem with any part of a Lakes product, we will sort it out, quickly. Our efficient customer service support means spare parts will most likely arrive the next day. Another reason why we're recommended by homeowners, stockists and installers across the UK.

For more information on the guarantee for shower trays please contact us directly.



Carbon Neutral & Sustainable

Lakes has taken steps to be certified Carbon Neutral by changing how we operate as a business. Naturally, we recycle all our product, site and office waste.

Our product packaging is 100% recyclable too, plus we're working with customers to take back our used packaging from installers through participating stockists. This step alone will remove 2,000 kilometres of plastic banding and two million pieces of polystyrene a year from landfill.

We continue to work with Carbon Footprint Ltd to offset the carbon emissions produced in the day-to-day running of our business by investing in environmental projects.

Lakes is proud to have been awarded the Carbon Footprint Standard and recognised as a Carbon Neutral Plus organisation.



What our customers say

“ Keep doing what you always have done. Nobody can ask any more of a supplier. Thanks for 14 years of great service. ”

Deb & Ralph Crook, RJC

“ You deserve recognition and praise for the service I received from you today. You answered the phone very promptly and managed to quickly find the shower door for which I needed a spare part. The two gentlemen I spoke to on separate calls could not have been more pleasant and helpful. If only more companies could behave in a similar fashion. ”

N Kelly

“ Superb quality, excellent after sales and a great prices. Thank you. ”

Diane Roberts

“ What a pleasure to be able to call a company and get through straight away. I purchased an ex-demo shower enclosure from a local shop. Unfortunately, lots of seals were missing and so were the instructions. After five extremely helpful minutes on the phone, I knew what I needed to do and the parts were sent to me in the post to me, free of charge. ”

Thank you.

Gary Wilton

“ The Lakes warranty is outstanding as is their customer service. ”

Victoria Klyve

“ I have found AllClear® brilliant. I live in an area where the water is particularly hard and AllClear® keeps my shower screen sparkling clean. The water seems to bounce off the glass, leaving no need for constant cleaning. I would definitely recommend this product. ”

Fiona Clissold, Trustpilot

“ The service has been second to none, going that extra mile to find a resolution and help with a replacement part for my shower. I would recommend Lakes to anyone, especially with your excellent after sales service. ”

Thank you.

John S Innes

“ My experience of aftercare/ customer service could only be described as 5 star. Having purchased shower doors and having managed to damage a part during fitting, I turned to Lakes hoping that a replacement was available and seeking to purchase the part needed. The response was instant. The email simply said part on its way and it was free. Nearly fell off my seat. Arrived 2 days later. Made my day to be honest. ”

Kelly Wilson, N. Ireland

“ Lakes spares department was outstanding. Craig was especially helpful and the quality of the shower enclosure must be the best on the market. ”

David Starkey

★ Trustpilot Excellent



4.6



Our new, highly versatile, modular walk-in range provides more solutions than most, with 28 walk-in showering configurations and six finishes to choose from. In short, customising and personalising your showering space has never been easier.

Pages 10-17



These beautifully engineered showering spaces featuring high-specification design and outstanding elegance, create a luxurious feel and have an instant calming effect.

Pages 18-33



Precision engineered, this new Collection achieves the perfect balance between function and design.

Pages 34-51



Let your shower take centre stage, or add a touch of understated elegance to a smaller space – the possibilities are endless with Coastline.

Pages 52-67

An introduction to Modular Walk-In Showers 10

Aruba	20
Antigua	22
Martinique	24
Grenada	26
Barbados	28
Cayman	30
Tobago	32

Hinged Door and Inline Panel	36
Hinged Door	38
Sliding Door	40
Single Door Quadrant	42
Double Door Quadrant	44
Bi-fold Door	46
Horizon Walk-In	48
Alassio Walk-in	50

Talsi	54
Malmo	56
Valmiera	58
Sorong	60
Bergen	62
Narva	64
Coastline Side Panel	66



Invigorate your senses with good looks and a quality finish.
Available in a configuration to suit your lifestyle.

Pages 68-99

Double Door Quadrant	70
Single Door Quadrant	72
Pivot Door with integrated In-line Panel	74
Pivot Door, Semi-framed	76
Bi-fold Door, Semi-framed	78
Seated Shower Tray and In-line Panel with Bi-fold and Pivot Door	80
Over Bath Double Door Slider	82
Slider Door, Semi-framed	84
Low Threshold Slider Door	86
Double Door Slider, Semi-framed	88
Corner Entry, Semi-framed	90
Pentagon, Semi-framed	92
Classic Side Panel, Framed	94
In-line Panel Pack	96
Seated Shower-Tray and Walk-In	98



Banish that unsightly, unhygienic shower curtain with a modern glass screen to add a touch of elegance.

Pages 100-111

Square Bath Screen	102
Square Hinged Bath Screen	103
Curved Bath Screen	104
Curved Hinged Bath Screen	105
Coastline Hinged Bath Screen	106
Classic Curved & Square Bath Screen	108
Classic Curved Hinged Bath Screen	110
Classic Shower Curtain Panel	111



Treat your feet with our tactile stone resin shower trays. The low profile and sleek designs look stunning in any bathroom.

Pages 112-121

Complementary Shower Trays	114
In The Detail	120



Small additions to your showering space can make all the difference, without compromising on quality or looks.

Pages 122-127

Shower Seats, Grab Bars & Rails	122
---------------------------------	-----



MODULAR WALK-IN

COLLECTION

Our new, highly versatile, modular walk-in range provides more solutions than most, with 28 walk-in showering configurations and six finishes to choose from. In short, customising and personalising your showering space has never been easier.

MODULAR WALK-IN FOR YOUR SHOWERING SPACE

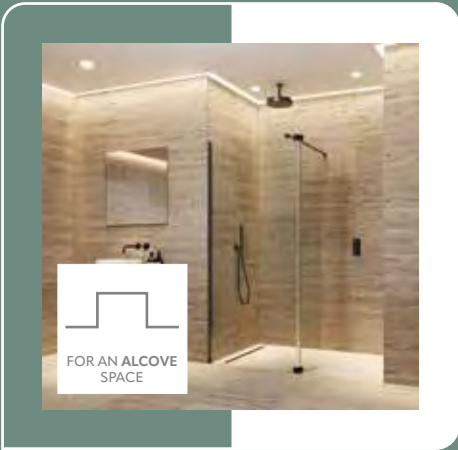

//RECESS/ALCOVE

Our modular walk-in systems can either be installed onto a shower tray or flush fit directly to a tiled wet room floor, providing great accessibility for the specific needs of individuals of all ages and challenges.

Lakes modular wet rooms are one of very few ranges that are compatible with almost any bathroom layout, size and user needs, combining safety, style and versatility in bathroom design and creating that spa look and feel. Suitable for recess, corner and flat-wall installations and where space in the bathroom is limited.

RECESS/ALCOVE

Ideal for smaller bathrooms, ensuite, guest rooms or loft conversions, but more often installed in the space where a bath is being removed and replaced with a shower.

Using one main fixed front panel on a floor substrate allows homeowners the flexibility to design a personalised and contemporary showering space and choose from one of six colour finishes. For added luxury [and keep the water within the showering area], add a fixed or hinged deflector panel.



//CORNER

CORNER

A corner space is often the most common area available and can offer more options in terms of form and function.

With more floor space often available, two panels [main/front with a return/side or return panel] can be used. This allows the walk-in layout to work more like a standard corner shower enclosure.

The side panel is a practical solution to simply preventing water splashing outside the showering area. Corner walk-in set-ups offer as much splash protection as a normal moving shower door. What's more, the 90° glass-to-glass join feature can be made to look minimal using a corner bracket and clear sealant or using a more traditional full height corner post.

FLAT WALL (3 -SIDED)

Not always reserved for larger bathrooms, but again it could be a space created as a result of a bath being replaced with a showering area. Unlike standard moving doors, creating a 3-sided enclosure with a modular walk-in set up is much easier than trying to design and install a customary enclosure with a sliding, bifold or hinged door. It's also much more cost effective.

Alternatively, a flat wall walk-in shower can also be configured as a 'walk-through' shower with double entry points, featuring a single fixed glass panel.

In summary, there's a Lakes walk-in shower set up to suit any size or shape of bathroom, and any budget .



//FLAT WALL



THREE SIDED WALK-IN GUN METAL
FOR A STRAIGHT, OPEN SPACE



CORNER WALK-IN FIXED DEFLECTOR IN BRUSHED NICKEL
FOR A CORNER SPACE



COLOUR FINISHES

To provide the ultimate in bathroom personalisation Lakes has carefully developed a collection of beautiful colour finishes for all metallic parts to suit individual tastes and complement any bathroom design scheme, providing the perfect accompaniment to today's showering and brassware fittings.

Choose from (left to right) Brushed Brass, Silver, Brushed Bronze, Gun Metal, Matt Black and Brushed Nickel.

MONOCHROME

Silver or Matt Black.

URBAN NEUTRAL

Gun Metal or Brushed Nickel.

NATURAL/WARM

Brushed Brass or Brushed Bronze.

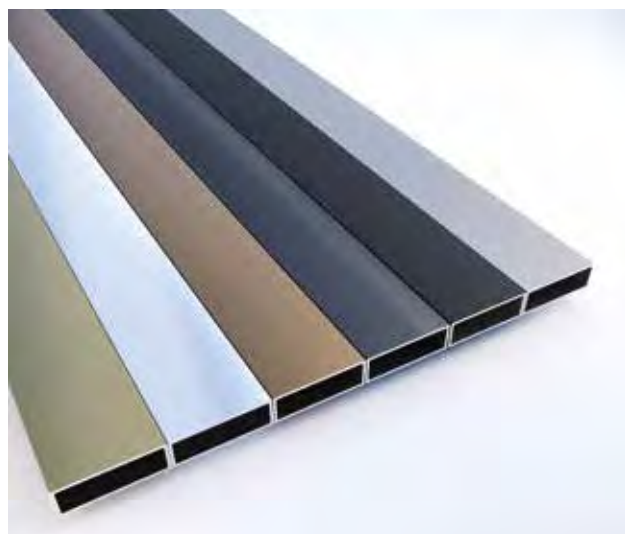

BRACING BAR SOLUTIONS

Whether your bathroom demands 1, 2 or 3 walk-in screens and a deflector panel, our elegant bracing bars will provide the perfect blend of form and function. Each option is superbly engineered for durability and strength with screw points discreetly concealed from view, on the wall or ceiling.



//BRACING BAR



//BRACING BAR



//BRACING BAR



//ANGLED BRACING BAR



//GLASS TO CEILING BRACING BAR



//FLOOR TO CEILING BRACING BAR



//CEILING BRACKET

PROFILE, CORNER AND SEAL SOLUTIONS

Our wall and corner profile solutions offer maximum versatility and stability and feature concealed fixings plus plenty of adjustability for those out of square walls.

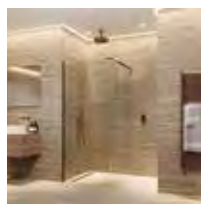

//WALL PROFILE

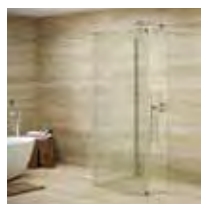

//CORNER BRACKET

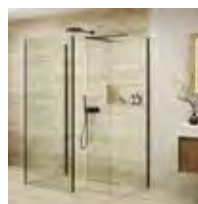

//CORNER POST

DEFLECTOR SOLUTIONS

To enrich your walk-in shower design and provide water overspray protection, choose from one of our sumptuous deflector panels options. Truly personalise your showering space by selecting from our friction-free rotating panels to provide easy walk-in access or opting for the ultimate spa/hotel style fixed deflector panel with clear seals. Rotating panels can also be retrofitted.

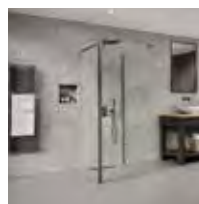

//FULL HEIGHT ROTATING DEFLECTOR HINGE AND PANEL



//HINGE TYPE DEFLECTOR PANEL



//FIXED 90° DEFLECTOR PANEL

SINGLE PANEL WITH FIXED DEFLECTOR IN BRUSHED BRONZE FOR AN ALCOVE SPACE



1

Select your showering space (recess, corner or flat wall).

2

Measure the floor space (width x depth) to include all wall tiles or wall coverings.

3

Choose your glass panels (8mm or 10mm) and glass size(s), plus a wall profile for each larger glass panel.

4

Select your bracing/stabilising preference to suit the number of glass panels, room construction and optional deflector panels.

5

Choose your glass connecting and deflector options.

6

Choose your colour finish and enjoy!

LAKES WALK-IN SHOWER CONFIGURATIONS

Infinite versatility. Design the walk-in layout that's perfect for your individual home, desired showering space, style, and dreams, from a wide range of 8mm and 10mm glass panel and hardware options.

Whether for recess, corner and flat wall all products are available in our six colour finishes.

The examples shown represent almost every configuration possible, but If you're considering something different to these, please consult your retailer for advice.

 Indicates rotating deflector panel

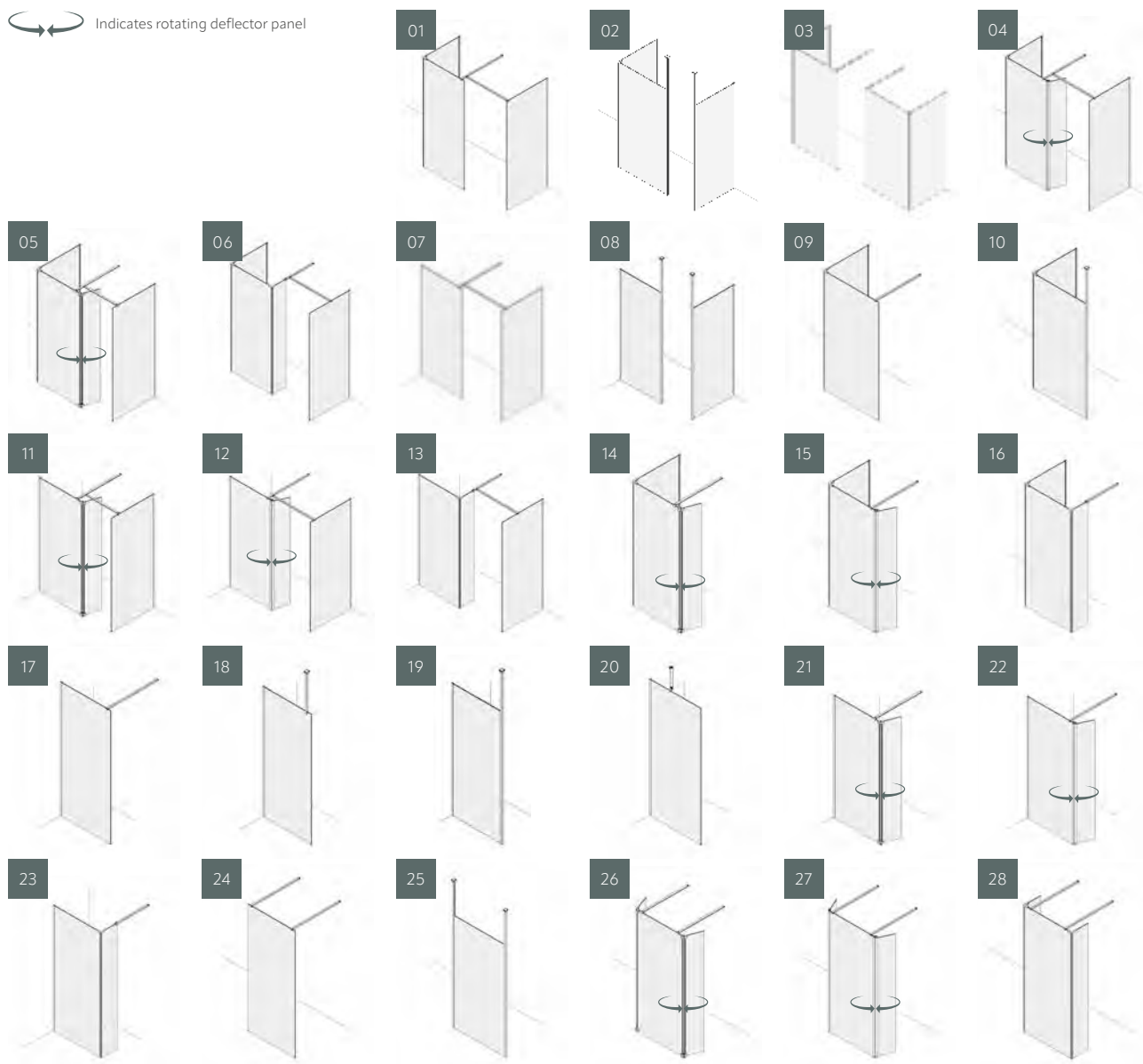

Shine
without
the high
maintenance

Island

COLLECTION

The understated elegance, sleek lines and high spec finishes of Island create a luxurious, boutique feel to be admired for years to come.



PureVue^{HD} Clearly Superior Glass

Aruba

The Aruba slider & side panel surrounds you with extensive glass for that ultimate feeling of light and space. This high specification design includes a chrome cast handle with matching profile caps, PureVue^{HD} for ultra-clear glass, a low threshold for easy and safe access, and a softly closing door that glides effortlessly to a near-silent stop at the touch of a finger.

from £1,655.10 incl. VAT

Aruba Slider 1000mm LK860-100S & LK860-100DG with Aruba Side Panel 700mm LK861-070S

Specification and Prices

Slider (A)

You must order BOTH product codes for your chosen size

Standard Size (A x height)	Width Adjustment	Door Opening	Fixed Panel (W)	Price excl. VAT	Price incl. VAT	Order Code
1000 x 2000	970 – 995	390	470 – 495	£710.01	£1065.61	1 x LK860-100S & 1 x LK860-100DG
1100 x 2000	1070 – 1095	440	520 – 545	£929.75	£1,115.49	1 x LK860-110S & 1 x LK860-110DG
1200 x 2000	1170 – 1195	490	570 – 595	£974.92	£1,169.91	1 x LK860-120S & 1 x LK860-120DG
1400 x 2000	1370 – 1395	590	670 – 695	£1,094.9	£1,313.88	1 x LK860-140S & 1 x LK860-140DG
1700 x 2000	1670 – 1695	740	820 – 845	£1,213.93	£1,456.71	1 x LK860-170S & 1 x LK860-170DG

15mm Extension Profile £41.94 incl. VAT (860-N Silver)

Please Note: To create your Aruba showering space you will need to select one product from each table.

Side Panel (B)

Standard Size (B x height)	Width Adjustment	Price excl. VAT	Price incl. VAT	Order Code
700 x 2000	670 – 695	£491.24	£589.49	LK861-070S
750 x 2000	720 – 745	£508.24	£609.89	LK861-075S
800 x 2000	770 – 795	£526.19	£631.43	LK861-080S
900 x 2000	870 – 895	£554.53	£665.44	LK861-090S
1000 x 2000	970 – 995	£581.93	£698.32	LK861-100S

15mm Extension Profile £41.94 incl. VAT (860-N Silver)

Antigua: Extension kit (860-N) may only be fixed to panel side. Aruba: Extension kit (860-N) may only be fixed to panel side of slider or to side panel'. OR: 'Extension kit (860-N) can be fitted to fixed panel of slider door and / or side panel (Aruba only).

All measurements are in mm

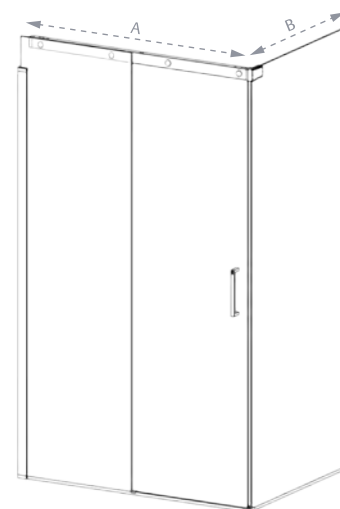



Pure
Vue^{HD}
Clearly
Superior
Class

Antiqua

The Antiqua slider has all the performance benefits of the Aruba, including a chrome cast handle and chrome profile caps as standard, but excludes the side panel for a stylish showering space fit for recess or alcove spaces.

from £1,065.61 incl. VAT

Antiqua Slider 1000mm LK860-100S & LK860-100DG

Specification and Prices

You must order BOTH product codes for your chosen size

Standard Size (width x height)	Width Adjustment	Door Opening	Fixed Panel (W)	Price excl. VAT	Price incl. VAT	Order Code
1000 x 2000	955 – 1000	370 – 390	470 – 495	£888.01	£1,065.61	1 x LK860-100S & 1 x LK860-100DG
1100 x 2000	1055 – 1100	420 – 440	520 – 545	£929.57	£1,115.49	1 x LK860-110S & 1 x LK860-110DG
1200 x 2000	1155 – 1200	470 – 490	570 – 595	£974.92	£1,169.91	1 x LK860-120S & 1 x LK860-120DG
1400 x 2000	1355 – 1400	570 – 590	670 – 695	£1094.9	£1,313.88	1 x LK860-140S & 1 x LK860-140DG
1700 x 2000	1655 – 1700	720 – 740	820 – 845	£1213.93	£1,456.71	1 x LK860-170S & 1 x LK860-170DG

15mm Extension Profile £41.94 incl. VAT (860-N Silver)

All measurements are in mm

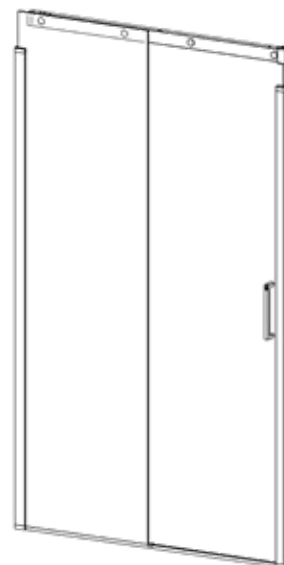



Martinique

Clean lines, stylish handle and refined hinges add to the beautiful, 'free-floating' design of the Martinique hinged panel and door.

from £1,464.65 incl. VAT

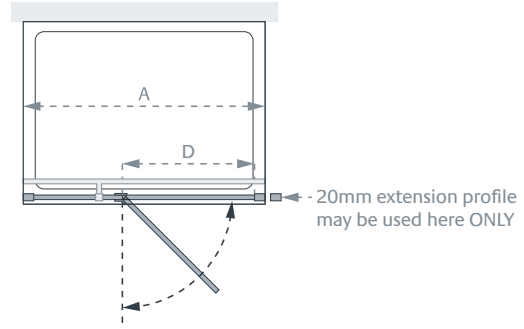

Specification and Prices

Door & Hinge Panel (A)

Standard Size (A x height)	Width Adjustment	Door Opening (D)	Price excl. VAT	Price incl. VAT	Order Code
1200 x 2000	1160 - 1205	628*	£1,220.54	£1,464.65	1 x LK804-070S & 1 x LK803-050S
1400 x 2000	1360 - 1405	628*	£1,265.88	£1,519.06	1 x LK804-070S & 1 x LK803-070S
1600 x 2000	1560 - 1605	628*	£1,313.12	£1,575.74	1 x LK804-070S & 1 x LK803-090S

20mm Extension Profile £34.01 incl. VAT (LK8LEPS Silver)

Martinique can be adjusted for out-of-plumb walls by a maximum of 15mm (for each mounting wall) over the height of the product. The hinge provides a further 15mm adjustment.

The required Bracing Bar for the Hinge Panel is included.

All measurements are in mm



Grenada

Beautifully understated and inspired by Grenada's wide horizons, this showering space surrounds you with crystal clear, frameless glass.

from £1,587.75 incl. VAT



Grenada 900mm LK801-090S Hinged Door & 900mm LK805-090S Side Panel

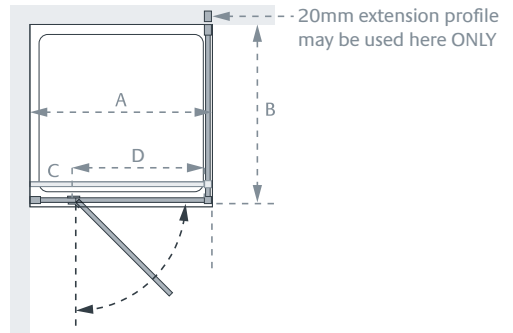

Specification and Prices

Door & Hinge Panel (A)

Standard Sizes (A x height)	Width Adjustment	Door Opening (D)	Price excl. VAT	Price incl. VAT	Order Code
750 x 2000	720 - 750	488	£859.67	£1,031.60	LK801-075S
800 x 2000	760 - 790	528	£868.17	£1,041.80	LK801-080S
900 x 2000	860 - 890	628	£892.73	£1,071.38	LK801-090S
1000 x 2000	960 - 990	728	£916.65	£1,099.62	LK801-100S

Please Note: To create your Grenada showering space you will need to select one product from each table.

Side Panel (B)

Standard Sizes (B x height)	Width Adjustment	Price excl. VAT	Price incl. VAT	Order Code
700 x 2000	670 - 685	£356.15	£427.38	LK805-070S
750 x 2000	730 - 745	£369.37	£443.25	LK805-075S
800 x 2000	770 - 785	£379.77	£455.72	LK805-080S
900 x 2000	870 - 885	£403.38	£484.06	LK805-090S
1000 x 2000	970 - 985	£427.00	£512.40	LK805-100S

You must also order the following Bracing Bar to secure the Side Panel.

Bracing Bar (C)

	Price excl. VAT	Price incl. VAT	Order Code
Bracing Bar	£107.31	£128.77	W8-052

20mm Extension Profile £34.01 incl. VAT (LK8LEPS Silver)

Grenada can be adjusted for out-of-plumb walls by a maximum of 15mm (for each mounting wall) over the height of the product. The hinge provides a further 15mm adjustment.

Not suitable for installations with tray rims <50mm wide.

All measurements are in mm



Barbados

Less really is more with this frameless hinged door. Simple lines and sparkling glass evoke the natural beauty and laid-back style of the Caribbean for a truly relaxing experience.

from £1,031.60 incl. VAT



Barbados 900mm 1 x LK801-090S

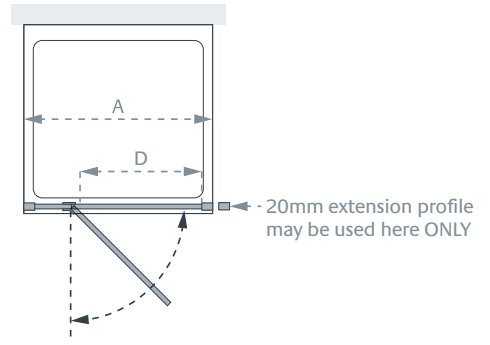

Specification and Prices

Door & Hinge Panel (A)

Standard Sizes (A x height)	Width Adjustment	Door Opening (D)	Price excl. VAT	Price incl. VAT	Order Code
750 x 2000	720 - 765	428	£859.67	£1,031.60	LK801-075S
800 x 2000	760 - 805	528	£868.17	£1,041.80	LK801-080S
900 x 2000	860 - 905	628	£892.74	£1,071.28	LK801-090S
1000 x 2000	960 - 1005	728	£916.35	£1,099.62	LK801-100S

20mm Extension Profile £34.01 incl. VAT (LK8LEPS Silver)

Barbados can be adjusted for out-of-plumb walls by a maximum of 15mm (for each mounting wall) over the height of the product.

The hinge provides a further 15mm adjustment.

All measurements are in mm



PureVue^{HD} Clearly Superior Glass

Cayman

Step barefoot into the embrace of our Cayman hinged door with in-line panel, bringing minimalist design to any alcove space and making the most of PureVue^{HD} crystal clear glass.

from £1,575.83 incl. VAT

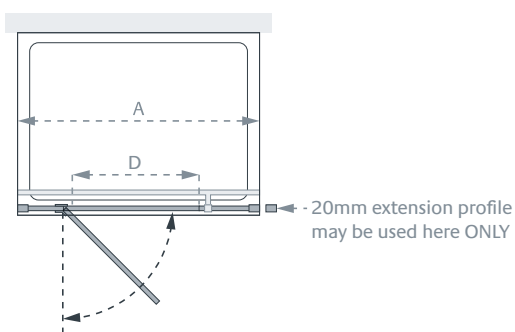

Specification and Prices

Door, Hinge Panel & In-line Panel (A)

Standard Size (A x height)	Width Adjustment	Door Opening (D)	Price excl. VAT	Price incl. VAT	Order Code
1200 x 2000	1160 - 1205	628*	£1,313.12	£1,575.83	1 x LK801-090S & 1 x LK802-030S
1400 x 2000	1360 - 1405	628*	£1,363.19	£1,635.83	1 x LK801-090S & 1 x LK802-050S
1600 x 2000	1560 - 1605	628*	£1,410.42	£1,692.51	1 x LK801-090S & 1 x LK802-070S

*Other 801 door sizes may be used to create alternative enclosure sizes – see Barbados on page 28.

20mm Extension Profile £34.01 incl. VAT (LK8LEPS Silver)

Cayman can be adjusted for out-of-plumb walls by a maximum of 15mm (for each mounting wall) over the height of the product. The hinge provides a further 15mm adjustment.

The required Bracing Bar for the In-line Panel is included.

All measurements are in mm

Pure
Vue^{HD}
Clearly
Superior
Glass



Tobago

A combination of minimalist design and extensive glass makes Tobago the glistening jewel in the crown for this Collection.

from £1,892.03 incl. VAT

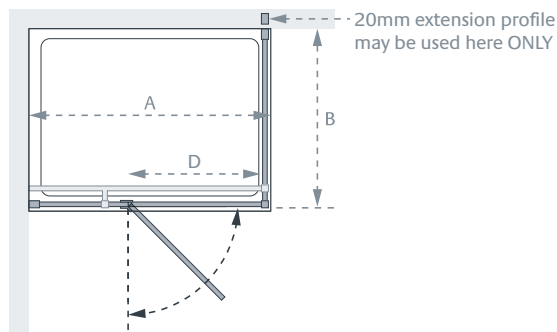

Specification and Prices

Door & Hinge Panel (A)

Standard Size (A x height)	Width Adjustment	Door Opening (D)	Price excl. VAT	Price incl. VAT	Order Code
1200 x 2000	1160 - 1190	628*	£1,220.54	£1,464.65	1 x LK804-070S & 1 x LK803-050S
1400 x 2000	1360 - 1390	628*	£1,265.88	£1,519.06	1 x LK804-070S & 1 x LK803-070S
1600 x 2000	1560 - 1590	628*	£1,313.12	£1,575.74	1 x LK804-070S & 1 x LK803-090S

Please Note: To create your Tobago showering space you will need to select one product from each table.

Side Panel (B)

Standard Size (B x height)	Width Adjustment	Price excl. VAT	Price incl. VAT	Order Code
700 x 2000	670 - 685	£356.15	£427.38	LK805-070S
750 x 2000	730 - 745	£369.37	£443.25	LK805-075S
800 x 2000	770 - 785	£379.77	£455.72	LK805-080S
900 x 2000	870 - 885	£403.38	£484.06	LK805-090S
1000 x 2000	970 - 985	£427.00	£512.40	LK805-100S

***Other door sizes may be used to create alternative enclosure sizes – please call Lakes for advice.**

20mm Extension Profile £34.04 incl. VAT (LK8LEPS Silver)

Tobago can be adjusted for out-of-plumb walls by a maximum of 15mm (for each mounting wall) over the height of the product. The hinge provides a further 15mm adjustment. The required Bracing Bar for the Hinge Panel and Side Panel is included. Not suitable for installations with tray rims <50mm wide.

All measurements are in mm



*Precision engineered,
Stylishly designed*

Wave

COLLECTION

Attention to detail is important. The precision engineered Wave Collection strikes a perfect balance between function and stylish design.

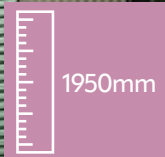

1950mm



Hinged Door and In-line Panel

Attention to detail is important. The precision engineered Wave Collection strikes a perfect balance between function and stylish design. The hinged door with in-line panel is no exception and is the latest addition to the range - the ideal choice for wider enclosure spaces.

from £1,042.73 inc. VAT

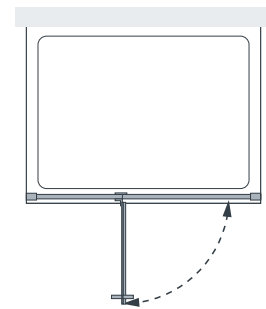

Specification and Prices

Standard Sizes (mm) (Width)	Silver (+S to end of code)	Matt Black (+B to end of code)	Brushed Brass (+BRS to end of code)	Width Adj't (mm)	Price Exc VAT (Silver)	Price Inc VAT (Silver)	Price Exc VAT (Matt Black)	Price Inc VAT (Matt Black)	Price Exc VAT (Brushed Brass)	Price Inc VAT (Brushed Brass)	Product Code
1000	Yes	Yes	Yes	950-1000	£868.94	£1,042.73	£881.46	£1,057.76	£969.61	£1,163.54	WAVHI100 & WAVHIDG
1100	Yes	Yes	Yes	1050-1100	£884.48	£1,061.38	£897.3	£1,076.76	£987.03	£1,184.44	WAVHI110 & WAVHIDG
1200	Yes	Yes	Yes	1150-1200	£900.09	£1,080.12	£913.22	£1,095.87	£1,004.54	£1,205.45	WAVHI120 & WAVHIDG
1300	Yes	Yes	Yes	1250-1300	£916.99	£1,100.39	£929.92	£1,116.53	£1,023.48	£1,228.18	WAVHI130 & WAVHIDG
1400	Yes	Yes	Yes	1350-1400	£931.77	£1,118.13	£945.5	£1,134.61	£1,040.05	£1,248.07	WAVHI140 & WAVHIDG
1500	Yes	Yes	Yes	1450-1500	£946.26	£1,135.52	£960.27	£1,152.33	£960.27	£1,267.57	WAVHI150 & WAVHIDG
1600	Yes	Yes	Yes	1550-1600	£960.88	£1,153.06	£957.17	£1,170.21	£1,072.68	£1,287.23	WAVHI160 & WAVHIDG
1700	Yes	Yes	Yes	1650-1700	£977.23	£1,172.68	£991.83	£1,190.21	£1,091.02	£1,309.23	WAVHI170 & WAVHIDG

Optional side panel*

Standard Sizes (mm) (Width)	Silver (+ S to end of code)	Matt Black (+ B to end of code)	Brushed Brass (+ BRS to end of code)	Width Adj't (mm)	Price Exc VAT (Silver)	Price Inc VAT (Silver)	Price Exc VAT (Matt Black)	Price Inc VAT (Matt Black)	Price Exc VAT (Brushed Brass)	Price Inc VAT (Brushed Brass)	Product Code
700	Yes	Yes	Yes	665 - 700	£313.96	£376.75	£319.99	£383.99	£352.00	£422.41	WAVSP070
750	Yes	Yes	Yes	715 - 750	£331.40	£397.68	£337.77	£405.33	£371.55	£445.86	WAVSP075
800	Yes	Yes	Yes	765 - 800	£354.29	£425.15	£361.10	£433.33	£397.21	£476.66	WAVSP080
900	Yes	Yes	Yes	865 - 900	£383.73	£460.47	£391.10	£469.33	£430.22	£516.27	WAVSP090
1000	Yes	Yes	Yes	965 - 1000	£434.96	£521.95	£443.33	£531.99	£487.66	£585.20	WAVSP100

*Optional side panels are 6mm glass. Door opening for all sizes is 624mm

15mm Extension Profile £47.28 incl. VAT (WAVLEPS Silver / WAVLEPB Black / WAVLEPBRB Brushed Brass) – see page 121.

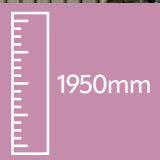

1950mm

Hinged Door

With easy access and understated looks, the hinged door is the perfect choice for a personal sanctuary or family showering space. Add to that the contemporary and elegant styling and it's easy to see why the hinged door is the perfect choice for a recessed showering space.

from £613.32 inc. VAT

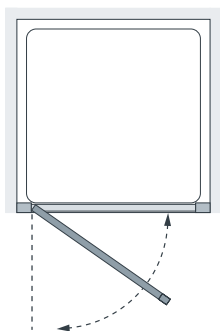
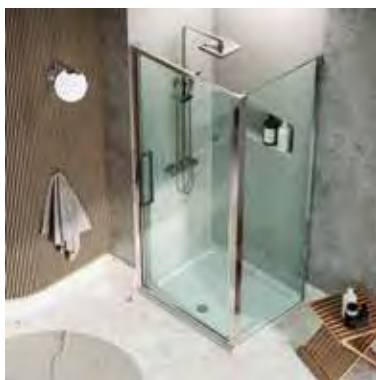

Specification and Prices

Hinged Door

Standard Sizes (mm) (Width)	Silver (+ S to end of code)	Matt Black (+ B to end of code)	Brushed Brass (+ BRS to end of code)	Width Adj't (mm)	Door Opening	Price Exc VAT (Silver)	Price Inc VAT (Silver)	Price Exc VAT (Matt Black)	Price Inc VAT (Matt Black)	Price Exc VAT (Brushed Brass)	Price Inc VAT (Brushed Brass)	Product Code
700	Yes	No	No	650 - 700	520	£511.10	£613.32	-	-	-	-	WAVH070
750	Yes	Yes	No	700 - 750	570	£530.89	£637.07	£541.10	£649.32	-	-	WAVH075
800	Yes	Yes	Yes	750 - 800	620	£544.88	£665.85	£565.55	£678.65	£622.09	£746.51	WAVH080
900	Yes	Yes	Yes	850 - 900	720	£588.67	£706.40	£599.99	£719.99	£659.99	£791.99	WAVH090
1000	Yes	Yes	Yes	950 - 1000	820	£621.37	£745.65	£633.32	£759.99	£696.66	£836.00	WAVH100

Optional side panel*

Standard Sizes (mm) (Width)	Silver (+ S to end of code)	Matt Black (+ B to end of code)	Brushed Brass (+ BRS to end of code)	Width Adj't (mm)	Price Exc VAT (Silver)	Price Inc VAT (Silver)	Price Exc VAT (Matt Black)	Price Inc VAT (Matt Black)	Price Exc VAT (Brushed Brass)	Price Inc VAT (Brushed Brass)	Product Code
700	Yes	Yes	Yes	665 - 700	£313.96	£376.75	£319.99	£383.99	£352.00	£422.41	WAVSP070
750	Yes	Yes	Yes	715 - 750	£331.40	£397.68	£337.77	£405.33	£371.55	£445.86	WAVSP075
800	Yes	Yes	Yes	765 - 800	£354.29	£425.15	£361.10	£433.33	£397.21	£476.66	WAVSP080
900	Yes	Yes	Yes	865 - 900	£383.73	£460.47	£391.10	£469.33	£430.22	£516.27	WAVSP090
1000	Yes	Yes	Yes	965 - 1000	£434.96	£521.95	£443.33	£531.99	£487.66	£585.20	WAVSP100

*Optional side panels are 6mm glass

15mm Extension Profile £47.28 incl. VAT (WAVLEPS Silver / WAVLEPB Black / WAVLEPBRB Brushed Brass) – see page 121.

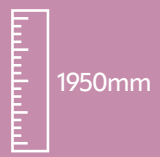

Sliding Door

As the door slides close with barely a whisper (as a result of the ultra-quiet closing quiet mechanism) and you see the simple clean lines of the shower door, it's not hard to imagine how the Wave slider helps create the perfect place to unwind and relax as well as enhance the beauty of your bathroom.

from £771.81 inc. VAT

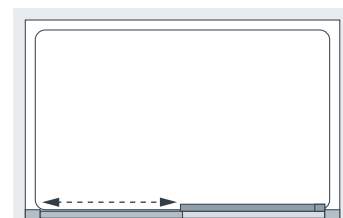
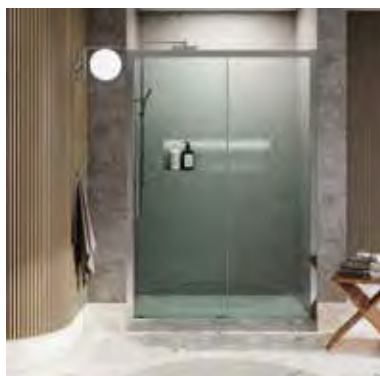
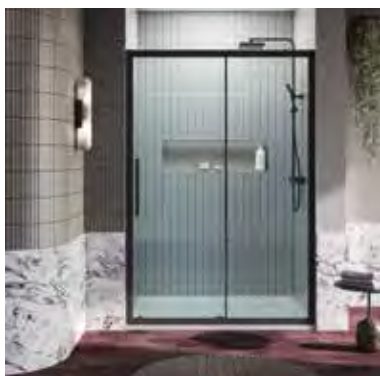

Specification and Prices

Sliding Door

Standard Sizes (mm) (Width)	Silver (+ S to end of code)	Matt Black (+ B to end of code)	Brushed Brass (+ BRS to end of code)	Width Adj't (mm)	Door Opening	Price Exc VAT (Silver)	Price Inc VAT (Silver)	Price Exc VAT (Matt Black)	Price Inc VAT (Matt Black)	Price Exc VAT (Brushed Brass)	Price Inc VAT (Brushed Brass)	Product Code
1000	Yes	Yes	Yes	950 - 1000	365	£643.18	£771.81	£655.54	£786.65	£721.10	£865.32	WAVS100
1100	Yes	Yes	Yes	1050 - 1100	415	£664.98	£797.97	£677.77	£813.32	£745.54	£894.65	WAVS110
1200	Yes	Yes	Yes	1150 - 1200	465	£675.88	£811.06	£688.88	£826.65	£757.77	£909.33	WAVS120
1400	Yes	Yes	Yes	1350 - 1400	565	£734.81	£881.77	£744.43	£893.32	£818.87	£935.76	WAVSF140 & WAVSDG140
1500	Yes	Yes	No	1450 - 1500	615	£775.08	£930.10	£785.40	£942.48	-	-	WAVSF150 & WAVSDG150
1600	Yes	No	No	1550 - 1600	665	£775.08	£930.10	-	-	-	-	WAVSF160 & WAVSDG160
1700	Yes	Yes	Yes	1650 - 1700	715	£841.98	£1,010.37	£853.32	£1,023.98	£938.65	£1,126.38	WAVSF170 & WAVSDG170

Fixed panel is 6mm glass

Optional side panel*

Standard Sizes (mm) (Width)	Silver (+ S to end of code)	Matt Black (+ B to end of code)	Brushed Brass (+ BRS to end of code)	Width Adj't (mm)	Price Exc VAT (Silver)	Price Inc VAT (Silver)	Price Exc VAT (Matt Black)	Price Inc VAT (Matt Black)	Price Exc VAT (Brushed Brass)	Price Inc VAT (Brushed Brass)	Product Code
700	Yes	Yes	Yes	665 - 700	£313.96	£376.75	£319.99	£383.99	£352.00	£422.41	WAVSP070
750	Yes	Yes	Yes	715 - 750	£331.40	£397.68	£337.77	£405.33	£371.55	£445.86	WAVSP075
800	Yes	Yes	Yes	765 - 800	£354.29	£425.15	£361.10	£433.33	£397.21	£476.66	WAVSP080
900	Yes	Yes	Yes	865 - 900	£383.73	£460.47	£391.10	£469.33	£430.22	£516.27	WAVSP090
1000	Yes	Yes	Yes	965 - 1000	£434.96	£521.95	£443.33	£531.99	£487.66	£585.20	WAVSP100

*Optional side panels are 6mm glass

15mm Extension Profile £47.28 incl. VAT (WAVLEPS Silver / WAVLEPB Black / WAVLEPBRS Brushed Brass) – see page 121.



Single Door Quadrant

With a stunning choice of finishes, our single door quadrant combines bold styling and a spacious yet unobtrusive showering space. Featuring a smooth and quiet sliding door, the Quadrant is also available offset with a left-hand or right-hand tray to suit your bathroom configuration.

from £927.38 inc. VAT

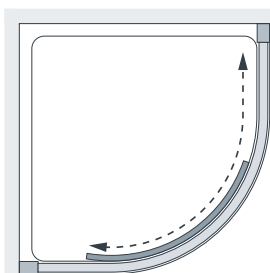

Single Door Quadrant

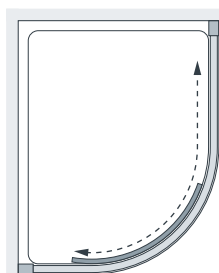

Offset Left-Hand Tray

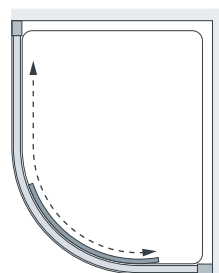

Offset Right-Hand Tray

Specification and Prices

Single Door Quadrant

Standard Sizes (mm) (Width x height)	Silver (+ S to end of code)	Matt Black (+ B to end of code)	Brushed Brass (+ BRS to end of code)	Width Adj't (mm)	Door Opening (mm)	Price Exc VAT (Silver)	Price Inc VAT (Silver)	Price Exc VAT (Matt Black)	Price Inc VAT (Matt Black)	Price Exc VAT (Brushed Brass)	Price Inc VAT (Brushed Brass)	Product Code
800 x 800	Yes	No	No	765-790	400	£772.82	£927.38	-	-	-	-	WAVRSD080 & WAVRSDDG
900 x 900	Yes	Yes	Yes	865 - 890	500	£816.42	£979.71	£862.65	£991.99	£909.31	£1,091.17	WAVRSD090 & WAVRSDDG
900 x 800	Yes	No	No	865 - 890 & 765 - 790	500	£825.14	£990.17	-	-	-	-	WAVRSD098 & WAVRSDDG
1000 x 800	Yes	Yes	Yes	965 - 990 & 765 - 790	500	£894.91	£1,073.9	£906.65	£1,087.98	£997.32	£1,196.79	WAVRSD108 & WAVRSDDG
1200 x 800	Yes	Yes	No	1165 - 1190 & 765 - 790	500	£957.05	£1,148.46	£969.98	£1,163.98	-	-	WAVRSD128 & WAVRSDDG
1200 x 900	Yes	Yes	No	1165 - 1190 & 865 - 890	500	£974.46	£1,169.39	£987.76	£1,185.32	-	-	WAVRSD129 & WAVRSDDG

15mm Extension Profile £4799 incl. VAT (WAVLEPS Silver / WAVLEPB Black / WAVLEPBRB Brushed Brass)

Note: Door closure is to 'flat' fixed panel only.

Wave Quadrant doors are 8mm glass and the fixed panels are 6mm glass.

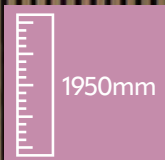

1950mm

Double Door Quadrant

As the doors effortlessly glide back, the generous space offered by this corner showering space beckons. As the double doors slide back, step into the generous space offered by this beautiful corner showering space. As with the single door Quadrant, the double door option is also available offset with a left-hand or right-hand tray depending on the layout of the bathroom.

from £860.39 inc. VAT

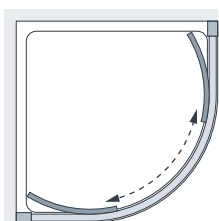

Double Door Quadrant

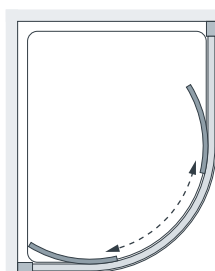

Offset Left-Hand Tray

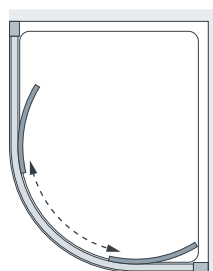

Offset Right-Hand Tray

Specification and Prices

Double Door Quadrant

Standard Sizes (mm) (Width x height)	Silver (+ S to end of code)	Matt Black (+ B to end of code)	Width Adj't (mm)	Door Opening (mm)	Price Exc VAT (Silver)	Price Inc VAT (Silver)	Price Exc VAT (Matt Black)	Price Inc VAT (Matt Black)	Product Code
800 x 800	Yes	No	765 - 790	390	£716.99	£860.39	-	-	WAVR080 & WAVRDG
900 x 900	Yes	Yes	865 - 890	550	£734.43	£881.32	£744.43	£893.32	WAVR090 & WAVRDG
1000 x 800	Yes	Yes	965 - 990 & 765 - 790	470	£786.76	£944.11	£797.76	£957.32	WAVR108 & WAVRDG
1200 x 800	Yes	Yes	1165 - 1190 & 765 - 790	470	£823.82	£988.59	£835.54	£1,002.65	WAVR128 & WAVRDG
1200 x 900	Yes	Yes	1165 - 1190 & 865 - 890	550	£1,012.13	£843.44	£855.54	£1,026.65	WAVR129 & WAVRDG

15mm Extension Profile £4799 incl. VAT (WAVLEPS Silver / WAVLEPB Black)

Wave Quadrant doors are 8mm glass and the fixed panels are 6mm glass.



Bifold Door

With great access, the benefits of a bifold are clear to see. Offering a versatile space-saving solution, the inward opening mechanism doesn't intrude into the bathroom space. This sleek semi-framed door is fully reversible with unique interlocking caps, making it easy to install.

from £726.02 inc. VAT

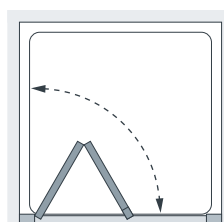

Specification and Prices

Bifold Door

Standard Sizes (mm) (Width)	Silver (+ S to end of code)	Matt Black (+ B to end of code)	Width Adjustment (mm)	Door Opening (mm)	Price Exc VAT (Silver)	Price Inc VAT (Silver)	Price Exc VAT (Matt Black)	Price Inc VAT (Matt Black)	Product Code
700	Yes	No	650 - 700	415	£605.02	£726.02	-	-	WAVB070
750	Yes	Yes	700 - 750	465	£630.09	£756.11	£642.21	£770.65	WAVB075
800	Yes	Yes	750 - 800	515	£664.98	£797.97	£677.77	£813.32	WAVB080
900	Yes	Yes	850 - 900	615	£706.40	£847.68	£719.99	£863.99	WAVB090
1000	Yes	Yes	950 - 1000	715	£760.91	£913.06	£775.54	£930.65	WAVB100

Optional Side Panel*

Standard Sizes (mm) (Width)	Silver (+ S to end of code)	Matt Black (+ B to end of code)	Width Adj't (mm)	Price Exc VAT (Silver)	Price Inc VAT (Silver)	Price Exc VAT (Matt Black)	Price Inc VAT (Matt Black)	Product Code
700	Yes	Yes	665 - 700	£313.96	£376.75	£319.99	£383.99	WAVSP070
750	Yes	Yes	715 - 750	£331.40	£397.68	£337.77	£405.33	WAVSP075
800	Yes	Yes	765 - 800	£354.29	£425.15	£361.10	£433.33	WAVSP080
900	Yes	Yes	865 - 900	£383.73	£460.47	£391.10	£469.33	WAVSP090
1000	Yes	Yes	965 - 1000	£434.96	£521.95	£443.33	£531.99	WAVSP100

*Optional side panels are 6mm glass

15mm Extension Profile £4799 incl. VAT (WAVLEPS Silver / WAVLEPB Black)

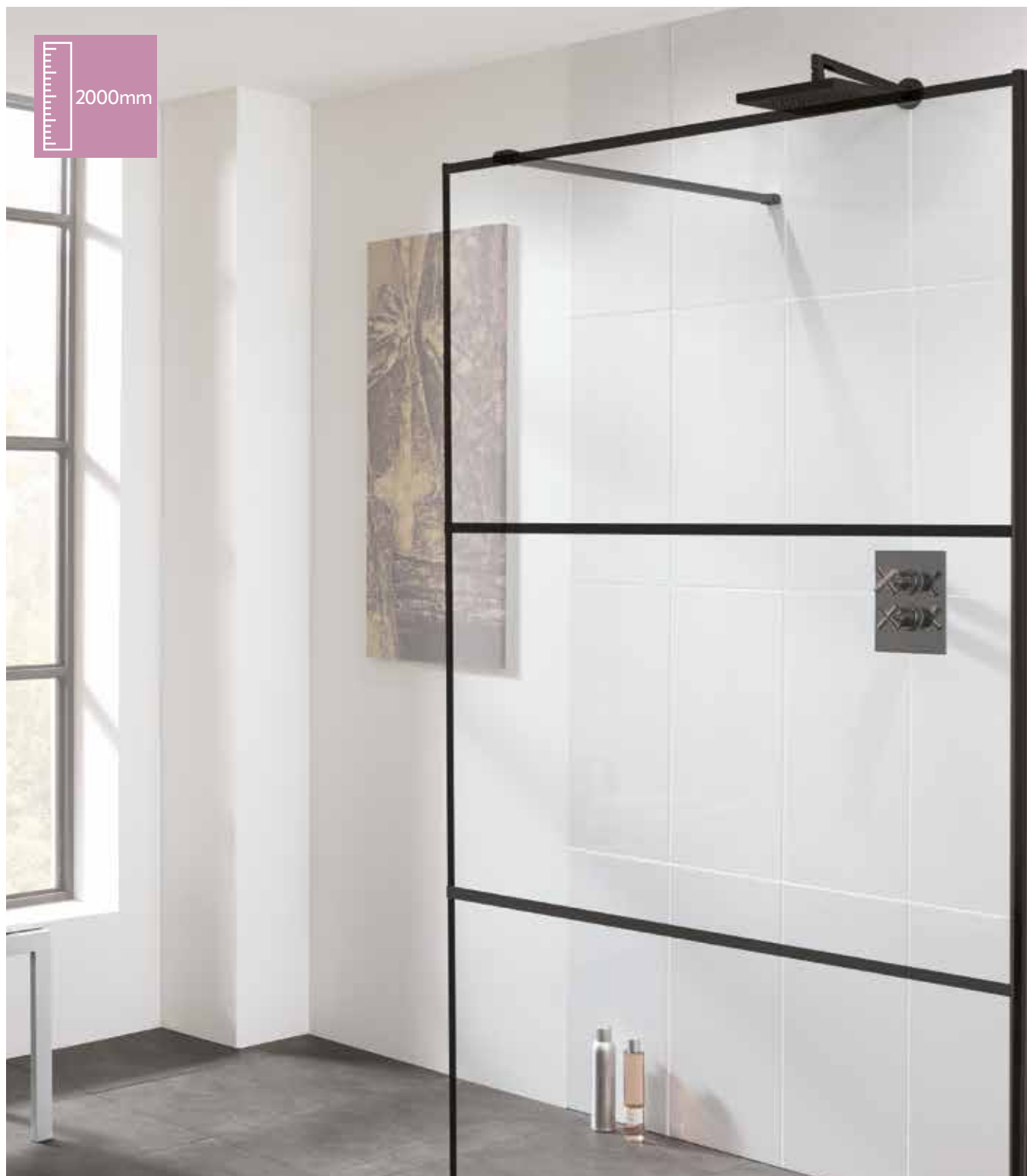
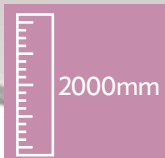

Horizon Walk-In

The simplicity and clean lines of the Wave walk-in gives an uninterrupted view of your bathroom. The striking matt black profiles with complementary horizon-style stripes on the glass make a bold and contemporary statement in any bathroom. The Horizon walk-in is also available with an optional hinged side panel which protects your bathroom from splashes while providing easy walk-in access. The hinged panel also features horizon style black stripes.

from £538.99 inc. VAT

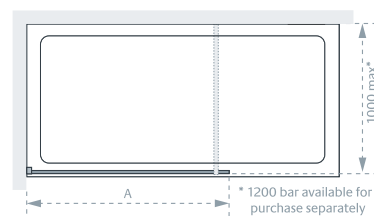

Shower Panel

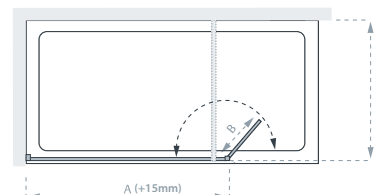

Shower Panel and Bypass Panel

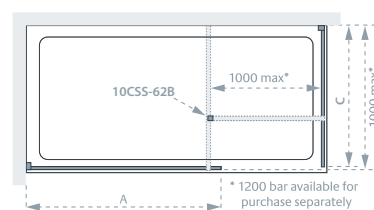

Shower Panel and Side Panel

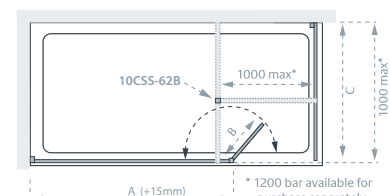

Shower Panel and Bypass Panel and Side Panel

Specification and Prices

Horizon Walk-In (A) and Optional Side Panel (C)

Standard Sizes (mm) (A & C x height)	Width Adjustment (mm)	Price Exc VAT	Price Inc VAT	Product Code
800 x 2000	755 - 770	£449.16	£538.99	LK851-080
900 x 2000	855 - 870	£478.33	£573.99	LK851-090
1000 x 2000	955 - 970	£565.82	£678.99	LK851-100
1100 x 2000	1065 - 1080	£595.96	£715.15	LK851-110
Optional Horizon Hinged Bypass Panel (B)				
300 x 2000	300	£309.16	£370.99	LK852-30

Note: Bypass panel (B) addition has effect of increasing width of panel A by 15mm

Black 90° Bar Joining Kit for Side Panel	£47.64	£57.16	10CSS-62B
*Black Extended Bracing Bar (1200mm - bar only)	£52.50	£63.00	10CSS-602B-120
Black Optional Ceiling Bracing Kit (suitable for 8 or 10mm glass)	£171.11	£205.33	W10-040B

20mm Extension Profile £33.02 incl. VAT (LK8LEPB Black)

Side Panel Walk-In available with or without Horizon stripes.



Alassio Walk In

The practical and flexible solution of Alassio includes a unique glass panel that rotates over 90 degrees each way from the centre point. This showering space is ideal for wet rooms or bathrooms where easy access is important. The wide opening makes cleaning a lot easier too!

from £516.23 incl. VAT





LK850-070S 700mm Alassio Hinged Shower Panel rotated to the right

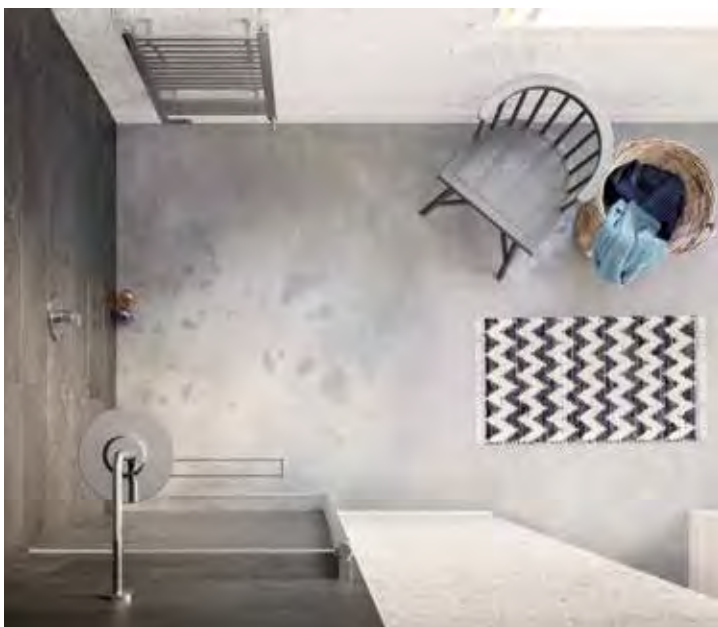

LK850-070S 700mm Alassio Hinged Shower Panel rotated to the left

Specification and Prices

Hinged Shower Panel (A)

Standard Sizes (A x height)	Width Adjustment	Price excl. VAT	Price incl. VAT	Order Code
700 x 1900	675 - 700	£430.19	£516.23	LK850-070S
800 x 1900	775 - 800	£461.67	£554.00	LK850-080S
900 x 1900	875 - 900	£495.05	£594.07	LK850-090S
1000 x 1900	975 - 1000	£528.44	£634.13	LK850-100S

All measurements are in mm

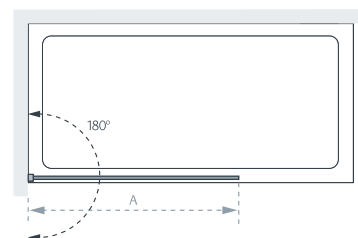

Hinged Shower Panel

A vintage Ford Thunderbird car is shown in a dark, moody setting. The car is the central focus, with its sleek lines and classic design elements visible. The text "Designed for life's journey" is written in a white, elegant script font across the middle of the car. The background is dark and textured, possibly a wall or a large piece of art. The overall mood is sophisticated and timeless.

Designed
for life's
journey



Coastline

COLLECTION

Designed with style for luxurious living, designed with easy maintenance for carefree enjoyment, designed with perfect detailing for pure pleasure. Designed to make every shower time well spent.

8mm Glass
Coastline



Talsi

Smooth in style and motion, the fluid nature of our Coastline slider perfectly embodies the versatility and design possibilities of this Collection.

from £1,007.80 incl. VAT



1 x 8HS120S & 1 x 8HS120DG 1200mm Talsi Slider Shower Door



Specification and Prices

Standard Sizes (width x height)	Width Adjustment	Door Opening	Price excl. VAT	Price incl. VAT	Order Code
1000 x 2000	940 - 1000	360	£839.83	£1,007.80	1 x 8HS100S & 1 x 8HS100DG
1100 x 2000	1040 - 1100	410	£870.06	£1,044.08	1 x 8HS110S & 1 x 8HS110DG
1200 x 2000	1140 - 1200	460	£904.06	£1,084.88	1 x 8HS120S & 1 x 8HS120DG
1300 x 2000	1240 - 1300	510	£934.77	£1,121.72	1 x 8HS130S & 1 x 8HS130DG
1400 x 2000	1340 - 1400	560	£965.48	£1,158.57	1 x 8HS140S & 1 x 8HS140DG
1500 x 2000	1440 - 1500	610	£995.71	£1,194.60	1 x 8HS150S & 1 x 8HS150DG
1600 x 2000	1540 - 1600	660	£1,026.87	£1,232.26	1 x 8HS160S & 1 x 8HS160DG
1700 x 2000	1640 - 1700	710	£1,076	£1,291.20	1 x 8HS170S & 1 x 8HS170DG

20mm Extension Profile £45.53 incl. VAT (8HLEPS Silver) – see page 121.
Compatible with Coastline Side Panel – see page 66.

All measurements are in mm

8mm Glass

Coastline



Malmo

Our Coastline corner entry adds another perspective to the chic design of this Collection. Mix and match from the panel sizes to create your perfectly proportioned showering space.

from £1,133.62 incl. VAT



Specification and Prices

Standard Sizes (width x height)	Width Adjustment	Price excl. VAT*	Price incl. VAT*	Order 2 sides for a complete enclosure
700 x 2000	660 - 690	£472.35	£566.81	8HC070S
750 x 2000	710 - 740	£504.46	£605.36	8HC075S
800 x 2000	750 - 780	£515.80	£618.96	8HC080S
900 x 2000	850 - 880	£549.81	£659.77	8HC090S
1000 x 2000	950 - 980	£582.87	£699.45	8HC100S

Door opening sizes

Panel Size	700	750	800	900	1000
700	330	345	360	400	442
750	345	365	385	423	463
800	360	385	395	436	475
900	400	423	436 ^B	465	506
1000	442 ^A	463	475	506	535

IMPORTANT: You must order any TWO product codes to create your chosen showering space. See example orders below:

Size (width x depth)	Door Opening Size	Price excl. VAT	Price incl. VAT	Order 2 sides for a complete enclosure
700 x 1000	See table above ^A	£1,055.22	£1,266.26	8HC070S & 8HC100S
800 x 900	See table above ^B	£1,022.16	£1,266.58	8HC080S & 8HC090S

20mm Extension Profile £45.53 incl. VAT (8HLEPS Silver)

All measurements are in mm



8mm Glass

Coastline

8mm Glass

Coastline



Valmiera

Our Coastline quadrant and offset quadrant design is the perfect blend of functionality and beautiful seamless curves to make the most of aesthetics and available space.

from £969.26 incl. VAT

1 x 8HR129S & 1 x 8HRDG 1200mm x 900mm
Valmiera Offset Quadrant



Quick Release for easy cleaning

Many of our shower doors have a 'quick release' spring mechanism at the bottom to make it easy to clean around the base and hard to reach areas. Simply push the buttons to release the bottom of the doors and then click back into place when done.

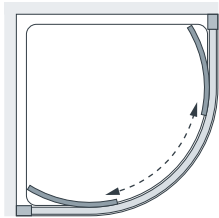

Quadrant

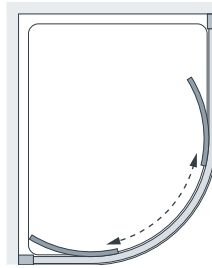

Offset Left-Hand Tray

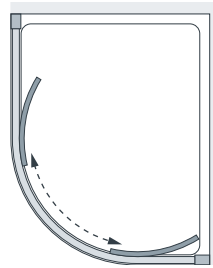

Offset Right-Hand Tray

Specification and Prices

Quadrant

You must order BOTH product codes for your chosen size.

Standard Sizes (width x height)	Width Adjustment	Door Opening	Price excl. VAT	Price incl. VAT	Order Code
800 x 2000	765 - 795	390	£807.71	£969.26	1 x 8HR080S & 1 x 8HRDG
900 x 2000	865 - 895	550	£838.75	£1,006.50	1 x 8HR090S & 1 x 8HRDG
1000 x 2000	965 - 995	550	£892.06	£1,070.47	1 x 8HR100S & 1 x 8HRDG

Offset Quadrant

You must order BOTH product codes for your chosen size.

Standard Sizes (w x d x h)	Width Adjustment	Door Opening	Price excl. VAT	Price incl. VAT	Order Code
900 x 800 x 2000	865-895 & 765-795	470	£832.68	£999.22	1 x 8HR098S & 1 x 8HRDG
1000 x 800 x 2000	965-995 & 765-795	470	£852.25	£1,022.70	1 x 8HR108S & 1 x 8HRDG
1200 x 800 x 2000	1165-1195 & 765-795	470	£903.53	£1,084.24	1 x 8HR128S & 1 x 8HRDG
1200 x 900 x 2000	1165-1195 & 865-895	550	£920.40	£1,104.48	1 x 8HR129S & 1 x 8HRDG

20mm Extension Profile £45.53 incl. VAT (8HLEPS Silver) – see page 121.

All measurements are in mm

8mm Glass
Coastline



Sorong

As a pure quadrant or offset, the single-door Sorong is a harmonious blend of clean lines and gentle curves.

from £1,064.80 incl. VAT

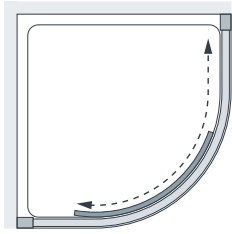

Single Door Quadrant

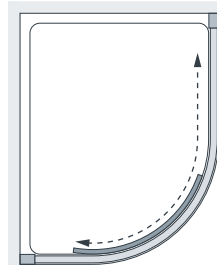

Offset Left-Hand Tray

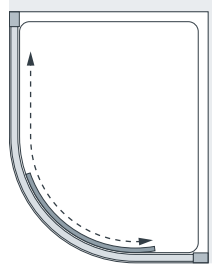

Offset Right-Hand Tray

Specification and Prices

Quadrant

You must order BOTH product codes for your chosen size.

Standard Sizes (width x height)	Width Adjustment	Door Opening	Price excl. VAT	Price incl. VAT	Order Code
800 x 2000	765 - 795	400	£887.35	£1,064.8	1 x 8HRSD080S & 1 x 8HRSDDG
900 x 2000	865 - 895	500	£922.42	£1,106.91	1 x 8HRSD090S & 1 x 8HRSDDG
1000 x 2000	965 - 995	500	£981.8	£1,178.16	1 x 8HRSD100S & 1 x 8HRSDDG

Offset Quadrant

You must order BOTH product codes for your chosen size.

Standard Sizes (w x d x h)	Width Adjustment	Door Opening	Price excl. VAT	Price incl. VAT	Order Code
900 x 760 x 2000	865-895 & 725-755	500	£906.9	£1,088.28	1 x 8HRSD0976S & 1 x 8HRSDDG
900 x 800 x 2000	865-895 & 765-795	500	£915.67	£1,098.81	1 x 8HRSD098S & 1 x 8HRSDDG
1000 x 800 x 2000	965-995 & 765-795	500	£935.91	£1,123.1	1 x 8HRSD108S & 1 x 8HRSDDG
1200 x 800 x 2000	1165-1195 & 765-795	500	£993.94	£1,192.74	1 x 8HRSD128S & 1 x 8HRSDDG
1200 x 900 x 2000	1165-1195 & 865-895	500	£1,010.81	£1,212.98	1 x 8HRSD129S & 1 x 8HRSDDG

20mm Extension Profile £45.53 incl. VAT (8HLEPS Silver) – see page 121.

All measurements are in mm



Coastline
8mm Glass



Bergen

Our Coastline bi-fold enhances the illusion of space without sacrificing elegance or style. Whether in an alcove or corner, it provides a sophisticated design solution.

from £1,109.82 incl. VAT



8HB090S 900mm Bergen Bi-fold Shower Door

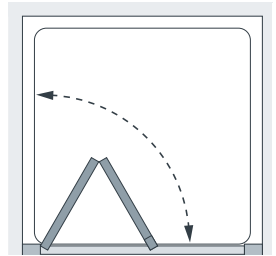

Specification and Prices

Standard Sizes (width x height)	Width Adjustment	Door Opening	Price excl. VAT	Price incl. VAT	Order Code
700 x 2000	660 - 720	395	£924.85	£1,109.82	8HB070S
750 x 2000	720 - 780	455	£992.87	£1,191.44	8HB075S
800 x 2000	760 - 820	495	£1,031.60	£1,031.60	8HB080S
900 x 2000	840 - 900	575	£1,112.85	£1,335.41	8HB090S
1000 x 2000	940 - 1000	675	£1,208.26	£1,449.91	8HB100S

20mm Extension Profile £45.53 incl. VAT (8HLEPS Silver) – see page 121.
 Compatible with Coastline Side Panel – see page 66.

All measurements are in mm





Narva

Whether combined with a side panel, or installed in an alcove, the slim profile of this pivot door underpins its sleek design.

from £702.85 incl. VAT

8HP090S 900mm Narva Pivot Shower Door

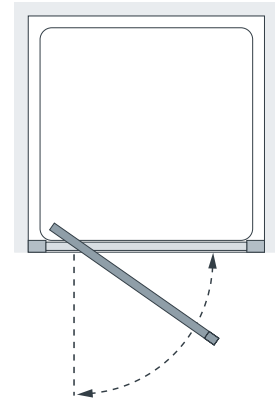

Specification and Prices

Standard Sizes (width x height)	Width Adjustment	Door Opening	Price excl. VAT	Price incl. VAT	Order Code
700 x 2000	660 - 720	423	£585.71	£702.85	8HP070S
750 x 2000	720 - 780	483	£607.44	£728.92	8HP075S
800 x 2000	760 - 820	513	£617.83	£741.39	8HP080S
900 x 2000	840 - 900	553	£646.17	£775.40	8HP090S
1000 x 2000	940 - 1000	603	£681.12	£817.35	8HP100S

20mm Extension Profile £45.53 incl. VAT (8HLEPS Silver) – see page 121.

Compatible with Coastline Side Panel – see page 66.

All measurements are in mm

6mm Glass

Coastline



Coastline side panel

A simple, yet beautifully designed panel that complements our Coastline doors, and makes your bathroom vision a reality, no matter what the plan or dimensions of your space.

from £482.93 incl. VAT



Specification and Prices

These side panels are available exclusively for use with the Coastline Collection. The panel is compatible with these models:

Code	Page	Code	Page	Code	Page
8HB	62	8HP	64	8HS	54

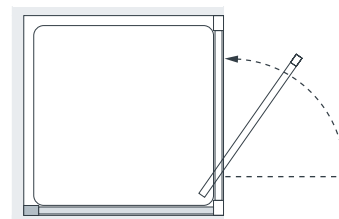

Standard Sizes (width x height)	Width Adjustment	Price excl. VAT	Price incl. VAT	Order Code
700 x 2000	670 - 700	£402.44	£482.93	8HSP070S
750 x 2000	720 - 750	£416.61	£499.93	8HSP075S
800 x 2000	770 - 800	£431.72	£518.07	8HSP080S
900 x 2000	870 - 900	£462.90	£555.48	8HSP090S
1000 x 2000	970 - 1000	£489.35	£587.22	8HSP100S

20mm Extension Profile £45.53 incl. VAT (8HLEPS Silver)

All measurements are in mm



A photograph of a person sitting in the driver's seat of a car, looking out the window. The entire image has a strong green color cast. The person's profile is visible in silhouette against the bright light coming through the window. The text is overlaid in the center of the image.

Space to breathe,
when the
door closes

A person is sitting in a train carriage, reading a magazine. The scene is captured from a low angle, showing the person's hands and the magazine. The train carriage has two large, rounded windows. The entire image has a teal or blue-green color cast. The magazine cover features a woman's face and the text "POCHTIS" and "Knoth".

Classic

COLLECTION

It's your time to be yourself, it's your showering space.
How do you want it? Stylish and practical? Smart and
affordable? Create a space that moves you.

6mm Glass

Classic



Double Door Quadrant

Designed with affordability in mind, the handsome curves of this corner design and spacious offset option are complemented by a subtly rounded profile.

from £696.03 incl. VAT

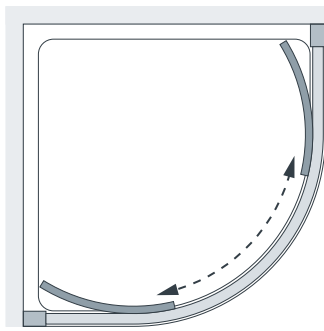

Double Door Quadrant

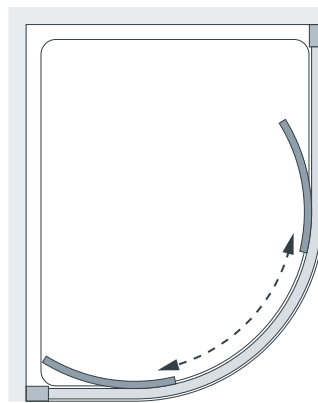

Offset Left-Hand Tray

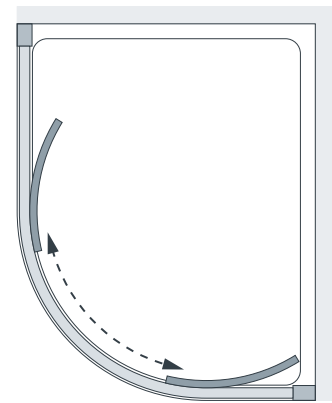

Offset Right-Hand Tray

Specification and Prices

Quadrant

Standard Sizes (width x height)	Width Adjustment	Door Opening	Price excl. VAT	Price incl. VAT	Previous Code	Order Code
800 x 1850	765 - 795	370	£580.03	£696.03	LKV2R800S	1 x CLV2R080S & 1 x CLV2RDG
900 x 1850	865 - 895	530	£594.28	£713.13	LKV2R900S	1 x CLV2R090S & 1 x CLV2RDG
1000 x 1850	965 - 995	530	£608.54	£730.24	LKV2R1000S	1 x CLV2R100S & 1 x CLV2RDG

Offset Quadrant

Standard Sizes (width x height)	Width Adjustment	Door Opening	Price excl. VAT	Price incl. VAT	Previous Code	Order Code
900 x 800 x 1850	865-895 x 765-795	450	£594.28	£713.13	LKV2R900800S	1 x CLV2R098S & 1 x CLV2RDG
1000 x 800 x 1850	965-995 x 765-795	450	£637.04	£764.45	LKV2R1000800S	1 x CLV2R108S & 1 x CLV2RDG
1200 x 800 x 1850	1165-1195 x 765-795	450	£667.34	£800.80	LKV2R1200800S	1 x CLV2R128S & 1 x CLV2RDG
1200 x 900 x 1850	1165-1195 x 865-895	530	£683.38	£820.05	LKV2R1200900S	1 x CLV2R129S & 1 x CLV2RDG

30mm Extension Profile £37.42 incl. VAT (LEPS Silver) – see page 121.

All measurements are in mm

6mm Glass

Classic



CLSDV2R129S & CLSDV2RDG 1200x900mm Silver Single Door Quadrant

Single Door Quadrant

An elegant and practical solution for corner spaces in smaller bathrooms or ensembles.
from £770.43 incl. VAT

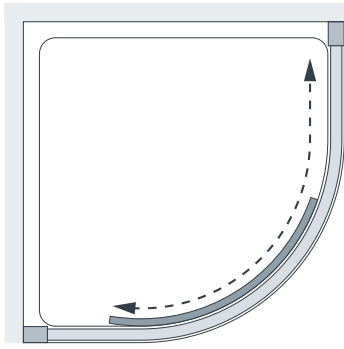

Single Door Quadrant

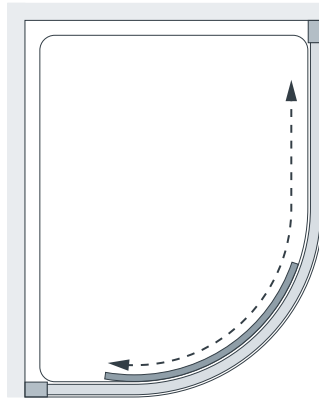

Offset Left-Hand Tray

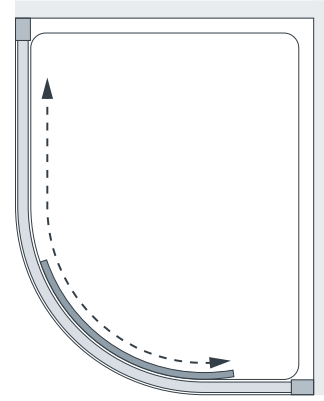

Offset Right-Hand Tray

Specification and Prices

Quadrant

Standard Sizes (width x height)	Width Adjustment	Door Opening	Price excl. VAT	Price incl. VAT	Previous Code	Order Code
800 x 1900	765 - 795	400	£642.02	£770.43	SDV2R080S	1 x CLSDV2R080S & 1 x CLSDV2RDG
900 x 1900	865 - 895	500	£678.71	£814.46	SDV2R090S	1 x CLSDV2R090S & 1 x CLSDV2RDG
1000 x 1900	965 - 995	500	£721.82	£866.18	SDV2R100S	1 x CLSDV2R100S & 1 x CLSDV2RDG

Offset Quadrant

Standard Sizes (width x height)	Width Adjustment	Door Opening	Price excl. VAT	Price incl. VAT	Order Code Silver	Order Code Silver
900 x 760 x 1900	865-895 x 725-755	500	£686.96	£824.36	SDV2R0976S	1 x CLSDV2R0976S & 1 x CLSDV2RDG
900 x 800 x 1900	865-895 x 765-795	500	£708.06	£849.68	SDV2R098S	1 x CLSDV2R098S & 1 x CLSDV2RDG
1000 x 800 x 1900	965-995 x 765-795	500	£745.66	£894.80	SDV2R108S	1 x CLSDV2R108S & 1 x CLSDV2RDG
1200 x 800 x 1900	1165-1195 x 765-795	500	£797.94	£957.54	SDV2R128S	1 x CLSDV2R128S & 1 x CLSDV2RDG
1200 x 900 x 1900	1165-1195 x 865-895	500	£811.70	£974.04	SDV2R129S	1 x CLSDV2R129S & 1 x CLSDV2RDG

Note: Door closure is to 'flat' fixed panel only.

All measurements are in mm

6mm Glass
Classic



LKVP1100S 1000mm Silver Pivot Door with integrated In-line Panel, Semi-framed

Pivot Door

with integrated
In-line panel

The seamless finish of this semi-framed pivot door is ideal for a wider showering space, with no profile between the door and the adjacent in-line panel.

from £650.46 incl. VAT

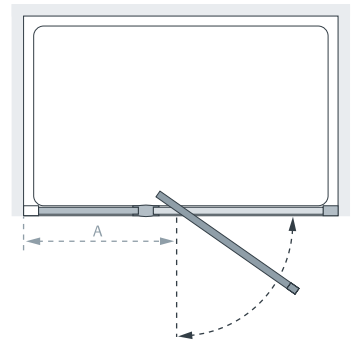

6mm Glass

Classic

Specification and Prices

Standard Sizes (width x height)	Width Adjustment	In-line Panel	Wall to door – at 90° open (A)	Door Opening	Price excl. VAT	Price incl. VAT	Order Code Silver
1000 x 1850	940 - 1000	149	315 - 345	555	£542.05	£650.46	LKVP1100S
1100 x 1850	1040 - 1100	249	415 - 445	555	£556.73	£668.07	LKVP1110S
1200 x 1850	1140 - 1200	349	515 - 545	555	£569.57	£683.48	LKVP1120S

30mm Extension Profile £37.42 incl. VAT (LEPS Silver) – see page 121.

Compatible with Classic Side Panel (LK1SPS Silver) – see page 94.

All measurements are in mm



6mm Glass
Classic

Pivot Door

Semi-framed

Deceptively simple, yet simply stunning. This semi-framed, pivot door creates a particularly slim profile to complement the simplicity of many modern bathrooms or ensuites.

from £502.98 incl. VAT



LKVP090S 900mm Silver Pivot Door, Semi-framed

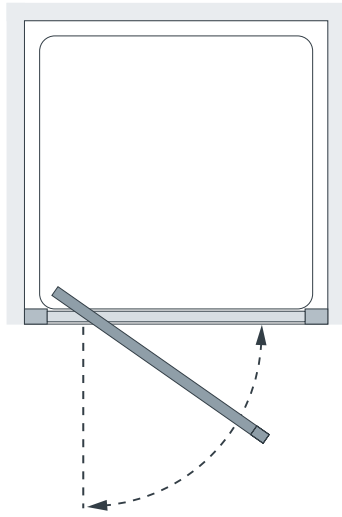

Specification and Prices

Standard Sizes (width x height)	Width Adjustment	Door Op*	Price excl. VAT	Price incl. VAT	Order Code Silver	Order Code White
700 x 1850	660 - 720	410	£419.15	£502.98	LKVP070S	LKVP070W
750 x 1850	720 - 780	470	£443.91	£532.70	LKVP075S	LKVP075W
800 x 1850	760 - 820	500	£463.17	£555.81	LKVP080S	LKVP080W
900 x 1850	840 - 900	540	£492.52	£591.03	LKVP090S	LKVP090W
1000 x 1850	940 - 1000	590	£520.04	£624.05	LKVP100S	N/A

*Door Op = Door Opening

30mm Extension Profile £37.42 incl. VAT (LEPS Silver, LEPW White) – see page 121.

Special height doors can be manufactured to order with an additional surcharge.

Compatible with Classic Side Panel (LK1SPS Silver, LK1SPW White) – see page 94.

All measurements are in mm

6mm Glass

Classic

Bifold Door

Semi-framed

Where space is at a premium, this simple, bi-fold design provides a stylish solution, complete with an attractive handle detail.
from £606.44 incl. VAT

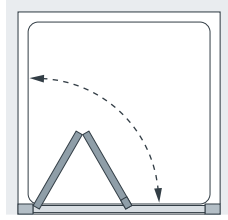

Specification and Prices

Standard Sizes (width x height)	Width Adjustment	Door Op*	Price excl. VAT	Price incl. VAT	Order Code Silver	Order Code White
700 x 1850	660 - 720	425	£505.36	£606.44	LKVB070S	LKVB070W
750 x 1850	720 - 780	485	£525.54	£630.65	LKVB075S	LKVB075W
800 x 1850	760 - 820	525	£555.81	£666.97	LKVB080S	LKVB080W
900 x 1850	840 - 900	605	£590.66	£708.79	LKVB090S	LKVB090W
1000 x 1850	940 - 1000	705	£635.60	£762.72	LKVB100S	-

*Door Op = Door Opening

30mm Extension Profile £37.42 incl. VAT (LEPS Silver, LEPS White) – see page 121.

Special height doors can be manufactured to order with an additional surcharge.

All measurements are in mm

LKVB090S 900mm Silver Bi-fold Door, Semi-framed



6mm Glass

Classic



LKST8015 Seated Shower Tray with LKIST7005 In-line Panel, LKVP0805 Pivot Door, Semi-framed and LKISP0805 Classic Side Panel, Framed

Seated Shower Tray and In-line panel

with Bi-fold and Pivot Door

With a beautifully raised seat that integrates into the tray, this showering space allows for comfort, ease and safety without compromising on style.

from £2,651.22 incl. VAT

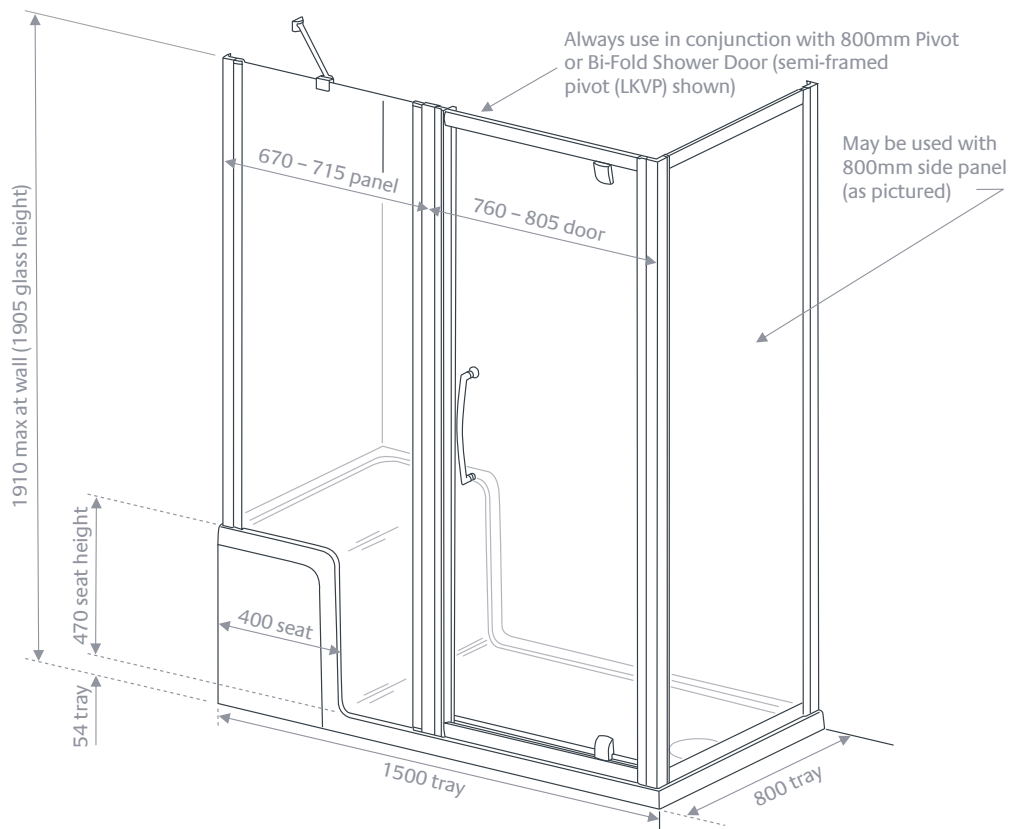

Specification and Prices

	Overall Size (width x height)	Width Adjustment	Door Opening	Price excl. VAT	Price incl. VAT	Order Code
In-line Panel (for Seat Tray)	700 x 1850	670 - 715	N/A	£398.97	£478.77	LKIST700S

Door Options	Overall Size (width x height)	Width Adjustment	Door Opening	Price excl. VAT	Price incl. VAT	Order Code
Semi-Framed Pivot	800 x 1850	760 - 805	500	£463.17	£555.81	LKVP080S
Semi-Framed Bi-fold	800 x 1850	760 - 805	525	£555.81	£666.97	LKVB080S

	Overall Size	Width Adjustment	Door Opening	Price excl. VAT	Price incl. VAT	Order Code
Shower Seat Tray	1500 x 800	N/A	N/A	£1,396.73	£1,676.07	LKST8015

800mm Classic Side Panel can be ordered separately for a corner installation – see pages 94.

All measurements are in mm

6mm Glass

Classic

LKV2BS170S 1700mm Silver Over Bath Double Door Slider, Semi-framed

Over Bath Double Door Slider

An elegant solution where space is at a premium, but you still want to have the choice between the pleasures of bathing or a real showering experience.

from £858.48 incl. VAT

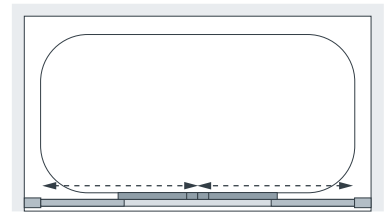

Over Bath Double Door Slider, Semi-framed with an added Side Panel

Specification and Prices

Door

Standard Sizes (width x height)	Width Adjustment	Price excl. VAT	Price incl. VAT	Order Code Silver
1700 x 1500	1640 - 1700	£715.40	£858.48	LKV2BS170S

30mm Extension Profile £37.42 incl. VAT (LEPS Silver) – see page 121.

All measurements are in mm

6mm Glass

Classic



Slides Door
Semi-framed

With a wide choice of sizes from 1000mm to 2000mm, this semi-framed slider gives you the freedom to create the perfect showering space for your bathroom.
from £646.06 incl. VAT



Quick Release for easy cleaning

Many of our shower doors have a 'quick release' spring mechanism at the bottom to make it easy to clean around the base and hard to reach areas. Simply push the buttons to release the bottom of the doors and then click back into place when done.

Specification and Prices

Where there are two codes you must order BOTH product codes for your chosen size.

Standard Sizes (width x height)	Width Adjustment	Door Opening	Price excl. VAT	Price incl. VAT	Previous Code	Order Code Silver	Order Code White
1000 x 1850	940 - 1000	360	£538.38	£646.06	N/A	LKV2S100S	LKV2S100W
1100 x 1850	1040 - 1100	410	£555.81	£666.97	N/A	LKV2S110S	LKV2S110W
1200 x 1850	1140 - 1200	460	£565.90	£679.08	N/A	LKV2S120S	LKV2S120W
1300 x 1850	1240 - 1300	510	£590.66	£708.79	N/A	LKV2S130S	N/A
1400 x 1850	1340 - 1400	560	£611.76	£734.11	N/A	LKV2S140S	N/A
1500 x 1850	1440 - 1500	610	£649.36	£779.23	N/A	LKV2S150S	N/A
1600 x 1850	1540 - 1600	660	£649.36	£779.23	N/A	LKV2S160S	N/A
1700 x 1850	1640 - 1700	710	£701.64	£841.97	LKV2S170S	1x CLV2SF170S & 1x CLV2S170DG	N/A
1800 x 1850	1740 - 1800	760	£726.40	£871.68	LKV2S180S	1x CLV2SF180S & 1x CLV2S180DG	N/A
2000 x 1850	1940 - 2000	860	£780.52	£936.62	LKV2S200S	1x CLV2SF200S & 1x CLV2S200DG	N/A

30mm Extension Profile £37.42 incl. VAT (LEPS Silver, LEPW White) – see page 121.

Note: Maximum adjustment range is reduced by 15mm when used in conjunction with the In-line Panel Pack – see page 96.

Special height doors can be manufactured to order with an additional surcharge.

Compatible with Classic Side Panel (LK1SPS Silver, LK1SPW White) – see page 94.

All measurements are in mm



LKV35120LS 1200mm Silver Left-Hand Low Threshold Slider Door, Semi-framed

Low Threshold Slider Door

Identical in every way to our popular semi-framed slider, the lower threshold allows you to step in and step out with ease.

from £873.88 incl. VAT

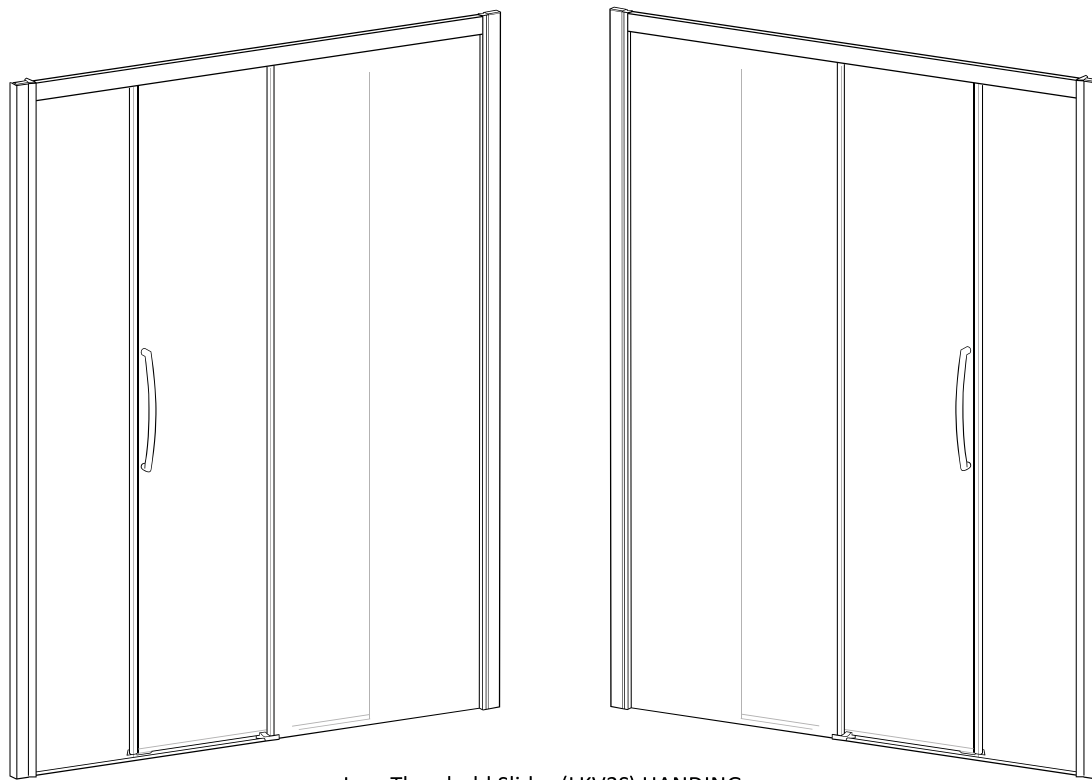

LEFT HAND

Low Threshold Slider (LKV3S) HANDING.
(door position when viewed from FRONT)
(or door closing direction)

RIGHT HAND

Specification and Prices

Where there are two codes you must order BOTH product codes for your chosen size.

Standard Sizes (width x height)	Width Adjustment	Door Opening	Price excl. VAT	Price incl. VAT	Previous Code	Order Code Left-Hand	Order Code Right-Hand
1000 x 1850	940 - 1000	360	£728.24	£873.88	N/A	LKV3S100LS	LKV3S100RS
1100 x 1850	1040 - 1100	410	£748.41	£898.10	N/A	LKV3S110LS	LKV3S110RS
1200 x 1850	1140 - 1200	460	£764.01	£916.81	N/A	LKV3S120LS	LKV3S120RS
1300 x 1850	1240 - 1300	510	£797.03	£956.43	N/A	LKV3S130LS	LKV3S130RS
1400 x 1850	1340 - 1400	560	£825.46	£990.55	N/A	LKV3S140LS	LKV3S140RS
1500 x 1850	1440 - 1500	610	£877.74	£1,053.28	LKV3S150LS / LKV3S150RS	1 x CLV3SF150LS & 1 x CLV3S150DG	1 x CLV3SF150RS & 1 x CLV3S150DG
1600 x 1850	1540 - 1600	660	£877.74	£1,053.28	LKV3S160LS / LKV3S160RS	1 x CLV3SF160LS & 1 x CLV3S160DG	1 x CLV3SF160RS & 1 x CLV3S160DG
1700 x 1850	1640 - 1700	710	£945.61	£1,134.73	LKV3S170LS / LKV3S170RS	1 x CLV3SF170LS & 1 x CLV3S170DG	1 x CLV3SF170RS & 1 x CLV3S170DG
1800 x 1850	1740 - 1800	760	£979.54	£1,175.45	LKV3S180LS / LKV3S180RS	1 x CLV3SF180LS & 1 x CLV3S180DG	1 x CLV3SF180RS & 1 x CLV3S180DG

Please note: fixed panel is 6mm glass, door panel is 8mm glass. The Low Threshold does not include a bottom rail or rollers.
30mm Extension Profile £37.42 incl. VAT (LEPS Silver) – see page 121.

Note: Maximum adjustment range is reduced by 15mm when used in conjunction with the In-line Panel Pack – see page 96.
Compatible with Classic Side Panel, framed (LK1SPS Silver) – see page 94.

All measurements are in mm

6mm Glass

Classic

LKV2DS160S1600mm Silver Double Slider Door, Semi-framed

88

Double Door Slider Semi-framed

Sleek and practical, the smooth running double door design offers easy access to your showering space.

from £794.64 incl. VAT

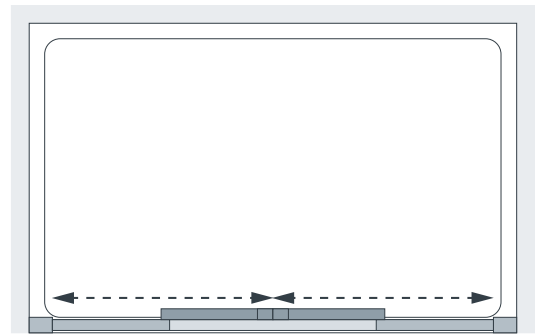

Double Door slider, Semi-framed with Classic Side Panel

6mm Glass

Classic

Specification and Prices

Where there are two codes you must order BOTH product codes for your chosen size.

Standard Sizes (width x height)	Width Adjustment	Door Opening	Price excl. VAT	Price incl. VAT	Previous Code	Order Code Silver
1200 x 1850	1140 - 1200	430	£662.20	£794.64	N/A	LKV2DS120S
1400 x 1850	1340 - 1400	530	£707.14	£848.57	N/A	LKV2DS140S
1500 x 1850	1440 - 1500	580	£730.07	£876.09	N/A	LKV2DS150S
1600 x 1850	1540 - 1600	630	£759.42	£911.31	N/A	LKV2DS160S
1700 x 1850	1640 - 1700	680	£782.35	£938.82	N/A	LKV2DS170S
1800 x 1850	1740 - 1800	730	£807.11	£968.54	LKV2DS180S	1 x CLV2DSF180S & 1 x CLV2DS180DG
2000 x 1850	1940 - 2000	830	£862.14	£1,034.57	LKV2DS200S	1 x CLV2DSF200S & 1 x CLV2DS200DG

30mm Extension Profile £37.42 incl. VAT (LEPS Silver) – see page 121.

Compatible with Classic Side Panel, Framed (LK1SPS Silver) – see page 94.

All measurements are in mm

6mm Glass

Classic



Corner Entry

Semi-framed

With our easy glide system, simply slide back the doors of this corner entry, step in, engage the magnetic door sealing and enjoy an invigorating shower.

from £834.26 incl. VAT

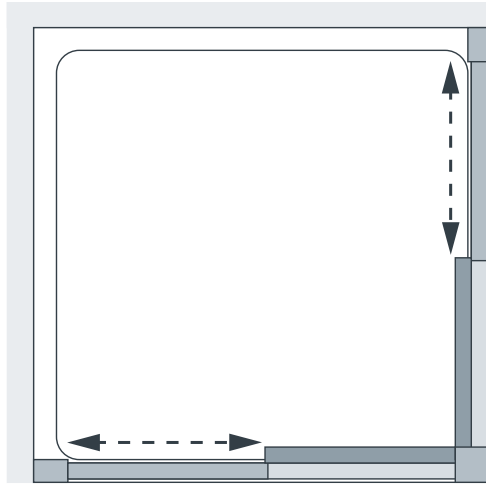

Specification and Prices

You must order **BOTH** product codes for your chosen size

Standard Sizes (width x height)	Width Adjustment	Door Op*	Price excl. VAT	Price incl. VAT	Previous Code	Order Code Silver
750 x 1850	710 - 740	360	£695.22	£834.26	LKVC075S	2 x CLVC075S
800 x 1850	750 - 780	385	£720.90	£865.08	LKVC080S	2 x CLVC080S
900 x 1850	850 - 880	460	£761.26	£913.51	LKVC090S	2 x CLVC090S
1000 x 1850	950 - 980	530	£808.95	£970.74	LKVC100S	2 x CLVC100S

*Door Op = Door Opening

30mm Extension Profile £37.42 incl. VAT (LEPS Silver, LEPW White) – see page 121.

Special height doors can be manufactured to order with an additional surcharge.

Compatible with Classic Side Panel, Framed (LK1SPS Silver, LK1SPW White) – see page 94.

All measurements are in mm

2 x CLVC090S 900mm Silver Corner Entry, Semi-framed

6mm Glass

Classic



LPE34-40S Silver Pentagon with Pivot Door, Semi-framed

Pentagon

Semi-framed

Perfect for where space might prevent using a conventional corner unit, this practical semi-framed pentagon can be fitted with your choice of bi-fold or pivot door.

from £947.63 incl. VAT

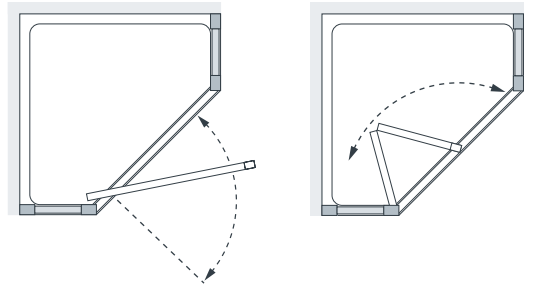

Specification and Prices

	Standard Sizes (width x height)	Width Adjustment	Door Opening	Price excl. VAT	Price incl. VAT	Order Code Silver
Pentagon Side Panels	350 x 1850	340 - 400	N/A	£370.54	£444.65	LPE34-40S
Semi-Framed Bi-fold Door	700 x 1850	660 - 720	425	£505.36	£606.44	LKVB070S
Semi-Framed Pivot Door	700 x 1850	660 - 720	420	£419.15	£502.98	LKVP070S

	Standard Size	Tray Type	Price excl. VAT	Price incl. VAT	Order Code
Pentagon Tray complete with 90mm waste	900 x 900	Low-Profile ABS Resin	£268.31	£321.97	TP99-ENG

All measurements are in mm



6mm Glass

Classic

LK1SP080S 800mm Silver Classic Side Panel, Framed shown with 1200mm Slider Door, Semi-framed



Classic Side Panel

Framed

Choose the shower door that suits the size and style of your bathroom and add a matching side panel to create your perfectly proportioned showering space.

from £313.67 incl. VAT

Specification and Prices

Standard Sizes (width x height)	Width Adjustment	Price excl. VAT	Price incl. VAT	Order Code Silver	Order Code White
700 x 1850	660 - 720	£261.39	£313.67	LK1SP070S	LK1SP070W
750 x 1850	720 - 780	£275.15	£330.18	LK1SP075S	LK1SP075W
800 x 1850	760 - 820	£294.41	£353.30	LK1SP080S	LK1SP080W
900 x 1850	840 - 900	£320.09	£384.11	LK1SP090S	LK1SP090W
1000 x 1850	940 - 1000	£363.20	£435.84	LK1SP100S	N/A
1100 x 1850	1040 - 1100	£397.14	£476.56	LK1SP110S	N/A
1200 x 1850	1140 - 1200	£422.82	£507.38	LK1SP120S	N/A



Special height doors can be manufactured to order with an additional surcharge.

All measurements are in mm

These Side Panels are available exclusively for use with specific Classic Collection products. The panel is compatible with these models:

Code	Page	Code	Page
CLV2R	70	CLV3S	86
LKVB	78	CLV2DS	88
LKVP	76	CLVC	90
LKVPI	74	LILPP	96
CLV2S	84	-	-

6mm Glass

Classic



In-line Panel Pack

Our In-line Panel Pack contains all you need to create a luxuriously sized showering space. The pack includes a panel, joining profile and bracing arm.

from £444.65 incl. VAT



LILPP350S 350mm Silver In-line Panel Pack shown with 800mm Pivot Door, Semi-framed



This In-line Panel Pack is available exclusively for use with the Classic Collection Semi-framed Bi-fold, Pivot and Slider Doors.

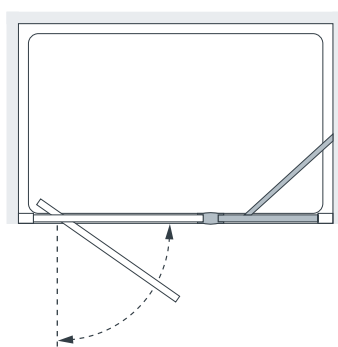

Specification and Prices

	Standard Size (width x height)	Width Adjustment	Price excl. VAT	Price incl. VAT	Order Code Silver	Order Code White
In-line Panel Pack	350 x 1850	340 - 385	£370.54	£444.65	LILPP350S	N/A
In-line Profile only	N/A	N/A	£41.27	£49.53	LIP-C004	N/A
In-line Bracing Arm only	N/A	N/A	£50.44	£60.53	BA-C350	N/A

Compatible with Classic Side Panel, Framed (LK1SPS Silver, LK1SPW White) – see page 94.

All measurements are in mm

6mm Glass

Classic



Seated Shower Tray and Walk-In

Walk in, take a seat and enjoy showering in comfort. A wonderfully elegant design solution that is ideal for multi-generational living.

from £2,710.64 incl. VAT

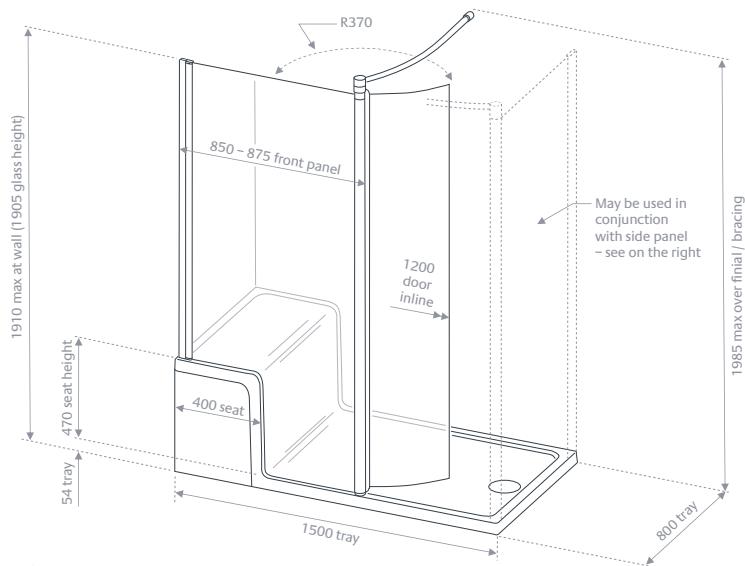

Left-Hand Unit

Walk-In Side Panel



6mm Glass

Classic

Specification and Prices

You must order BOTH product codes for your chosen size.

	Shaped Tray Panel Size (width x height)	Price excl. VAT	Price incl. VAT	Previous code	Order Code
LH Walk-In (for Seat Tray)	850 - 1850	£862.14	£1,034.57	LWSST1200L	1 x CLWSST120LS & 1 x CLWSDG
RH Walk-In (for Seat Tray)	850 - 1850	£862.14	£1,034.57	LWSST1200R	1 x CLWSST120RS & 1 x CLWSDG

	Overall Size (width x height)	Price excl. VAT	Price incl. VAT	Previous code	Order Code
Shower Seat Tray	1500 x 800	£1,396.73	£1,676.07	N/A	LKST8015

Optional Side Panel

A Walk-In side panel can be ordered separately for a corner installation.

Standard Sizes (width x height)	Width Adjustment	Recommended Tray Size Min	Recommended Tray Size Max	Price excl. VAT	Price incl. VAT	Order Code
800 x 1850 + 85	775 - 800	775	800	£345.77	£414.93	LWSP080S

All measurements are in mm

LKST8015 Seated Shower Tray with CLWSST120RS & CLWSDG Right-Hand Walk-In

A photograph of a baby sitting in a stroller, crying. The baby is wearing a patterned hat and a dark jacket. The image has a teal color overlay. Overlaid on the image is white text in a cursive font that reads "Robust enough to handle frequent Showers".

Robust enough
to handle
frequent
Showers



Bath Screens

COLLECTION

Finding a flexible solution for everyone can be a challenge. An invigorating shower for you; a splashy, squeaky bath time for the kids. It's good to know our stylish, watertight bath screens provide the best of both worlds.

BSA50S Silver Single Panel Square Bath Screen



Square Bath Screen

from £195.43 incl. VAT

Specification and Prices

Overall Size (width x height)	Width Adjustment	Price excl. VAT	Price incl. VAT	Colour	Order Code
800 x 1500	800 - 815	£162.86	£195.43	Silver	BSA50S
		£182.40	£218.88	Matt Black	BSA50B
		£192.17	£230.61	Brushed Brass	BSA50BRS

All measurements are in mm

BSA60BRS Brushed Brass Double Panel Curved Bath Screen



Square Hinged Bath Screen

from £357.39 incl. VAT

Specification and Prices

Overall Size (width x height)	Width Adjustment	Price excl. VAT	Price incl. VAT	Colour	Order Code
950 (309 + 641) x 1500	309 - 324	£297.83	£357.39	Silver	BSA60S
		£333.56	£400.28	Matt Black	BSA60B
		£351.43	£421.72	Brushed Brass	BSA60BRS

All measurements are in mm

6mm Glass

Bath Screens

BSA10S Silver Single Panel Curved Bath Screen



Curved Bath Screen

from £195.43 incl. VAT

Specification and Prices

Overall Size (width x height)	Width Adjustment	Price excl. VAT	Price incl. VAT	Colour	Order Code
800 x 1500	800 - 815	£162.86	£195.43	Silver	BSA10S
		£182.40	£218.88	Matt Black	BSA10B
		£192.17	£230.61	Brushed Brass	BSA10BRS

All measurements are in mm



Curved Hinged Bath Screen

from £357.39 incl. VAT

Specification and Prices

Overall Size (width x height)	Width Adjustment	Price excl. VAT	Price incl. VAT	Colour	Order Code
950 (309 + 641) x 1500	950 - 965	£297.83	£357.39	Silver	BSA20S
		£333.56	£400.28	Matt Black	BSA20B
		£351.43	£421.72	Brushed Brass	BSA20BRS

All measurements are in mm

Pure
Vue^{HD} Clearly
Superior
Glass

8mm Glass

Bath Screens



Coastline Hinged Bath Screen

Elegance and functionality combine to transform
any bath into a luxurious showering space.

from £602.38 incl. VAT

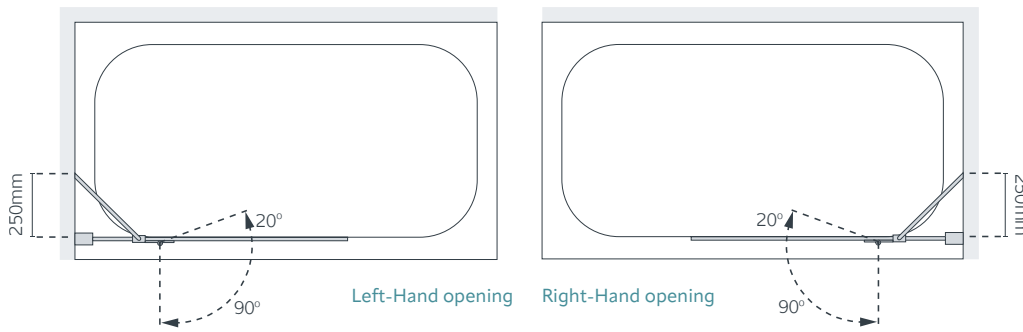

Specification and Prices

Overall Size (width x height)	Fixed Panel (width adjustment)	Hinged Panel	Price excl. VAT	Price incl. VAT	Order Code Left-Hand	Order Code Right-Hand
900 - 915 x 1500	292 - 307	608	£501.98	£602.38	SS100LS	SS100RS
1000 - 1015 x 1500	492 - 507	508	£521.25	£625.50	SS105LS	SS105RS

All measurements are in mm



*Classic Curved Bath Screen
and
Classic Square Bath Screen*

from £358.17 incl. VAT



Specification and Prices

	Standard Sizes (width x height)	Width Adjustment	Price excl. VAT	Price incl. VAT	Order Code Silver
Curved	800 x 1400	800 - 825	£298.47	£358.17	BS810S
Square	800 x 1500	800 - 825	£315.4	£378.48	BS850S

All measurements are in mm



Classic Curved Hinged Bath Screen

Ease of access, elegant curves and effective sealing combine for a practical and stylish bath and shower solution.

from £533.51 incl. VAT

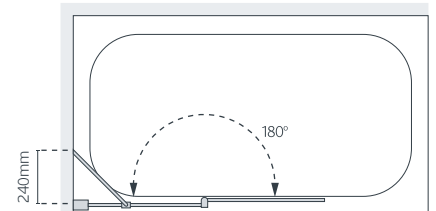

Specification and Prices

Overall Size (width x height)	Fixed Panel (width adjustment)	Door (width)	Price excl. VAT	Price incl. VAT	Colour	Order Code
930 - 955 x 1400	540 - 565	390	£444.59	£533.51	Silver	SS120S
			£471.27	£565.52	Matt Black	SS120B
			£518.39	£622.07	Brushed Brass	SS120BRS

All measurements are in mm



Classic Shower Curtain Panel

Our shower curtain panel is a fixed short screen that's styled and engineered to perfectly complement the use of a shower curtain by providing an additional barrier from water spray.

from £242.70 incl. VAT

Specification and Prices

Overall Size (width x height)	Width Adjustment	Price excl. VAT	Price incl. VAT	Order Code Silver
300 x 1400	298 - 323	£202.25	£242.70	SS90S
300 x 1500	298 - 323	£215.61	£258.74	SS95S

All measurements are in mm

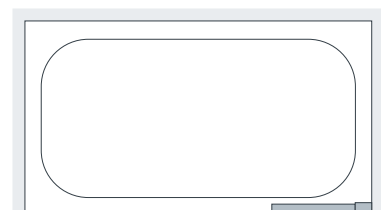



Every part
has a role to play



Shower Trays
and Accessories
COLLECTION

It's the level of detail we go to that makes our showering paces special for everyone. From luxurious, tactile trays to beautifully crafted, sleek handles and seats. Every component is built to last.

Stone Resin & Linear Trays

Superbly engineered and produced in the UK to the most exacting standards. Modern, minimalist low-profile form with a truly comfortable standing area, exceptional water draining capacity, available as standard or slip resistant and the perfect partner to Lakes shower doors..

For size specifications and prices go to pages 116 - 118.

Standard Tray Shapes

Trays can be supplied to fit all models. Quadrants are designed to fit a 550mm tray radius. All wastes are 90mm Ø



Square



Rectangular



Quadrant



Rectangular (centre waste)



Offset Quadrant

Tray Riser Kits

All our Easy-Plumb Kits are supplied complete with legs and panels.



Acrylic Capped Stone Resin (ABS) Tray and Easy-Plumb Kit

90mm Ø Waste.
Suitable for all Stone Resin trays



IMPORTANT: Waste positions vary depending on tray shape and size

For a full technical data sheet, visit <https://lakesshoweringspaces.com/technical-details/shower-trays/>



Stone Resin & Linear

Shower Trays

Stone Resin Trays

Please note: There is an additional £10 delivery charge when ordering a single tray without an enclosure.

Low Profile Trays

Tray Type	Product Code	Size (mm)	Additional Information	Material	excl. VAT	incl. VAT		
QUADRANT (550mm Radius)	ST88QW	800 x 800	Radius Edge Waste	ABS stone	£137.20	£164.64		
	ST99QW	900 x 900		ABS stone	£153.53	£184.24		
OFFSET QUADRANT (550mm Radius)	ST810QWL	800 x 1000 LH		ABS stone	£210.70	£252.84		
	ST810QWR	800 x 1000 RH		ABS stone	£210.70	£252.84		
	ST812QWL	800 x 1200 LH		ABS stone	£221.32	£265.58		
	ST812QWR	800 X 1200 RH		ABS stone	£221.32	£265.58		
	ST912QWL	900 X 1200 LH		ABS stone	£262.15	£314.58		
ST912QWR	900 X 1200 RH	ABS stone		£262.15	£314.58			
RECTANGULAR	ST79RW	700 x 900	Corner Waste	ABS stone	£185.38	£222.46		
	ST89RW	800 x 900		ABS stone	£185.38	£222.46		
	ST710RW	700 x 1000		ABS stone	£191.92	£230.30		
	ST7610RW	760 x 1000		ABS stone	£191.92	£230.30		
	ST810RW	800 x 1000		ABS stone	£191.92	£230.30		
	ST910RW	900 x 1000		ABS stone	£199.27	£239.12		
	ST811RW	800 x 1100		ABS stone	£199.27	£239.12		
	ST911RW	900 x 1100		ABS stone	£208.25	£249.90		
	ST712RW	700 x 1200		ABS stone	£199.27	£239.12		
	ST7612RW	760 x 1200		ABS stone	£200.08	£240.10		
	ST812RW	800 x 1200		ABS stone	£221.32	£265.58		
	ST912RW	900 x 1200		ABS stone	£238.47	£286.16		
	ST813RW	800 x 1300		ABS stone	£310.33	£372.40		
	ST714RW	700 x 1400		ABS stone	£322.58	£387.10		
	ST7614RW	760 x 1400		ABS stone	£320.13	£384.16		
	ST814RW	800 x 1400		ABS stone	£320.13	£384.16		
	ST914RW	900 x 1400		ABS stone	£337.28	£404.74		
	ST715RW	700 x 1500		ABS stone	£360.97	£433.16		
	ST7615RW	760 x 1500		ABS stone	£376.48	£451.78		
	ST815RW	800 x 1500		ABS stone	£381.38	£457.66		
	ST915RW	900 x 1500		ABS stone	£396.08	£475.30		
	ST716RW	700 x 1600		ABS stone	£425.48	£510.58		
	ST816RW	800 x 1600		ABS stone	£425.48	£510.58		
	ST916RW	900 x 1600		ABS stone	£441.82	£530.18		
	ST717RW	700 x 1700		ABS stone	£455.70	£546.84		
	ST7617RW	760 x 1700		ABS stone	£470.40	£564.48		
	ST817RW	800 x 1700		Center (long side) Waste	ABS stone	£512.05	£614.46	
	ST917RW	900 x 1700			ABS stone	£552.07	£662.48	
	SQUARE	ST70SW		700 x 700	Corner Waste	ABS stone	£111.88	£134.26
		ST76SW		760 x 760		ABS stone	£111.88	£134.26
		ST80SW		800 x 800		ABS stone	£129.85	£155.82
		ST90SW		900 x 900		ABS stone	£145.37	£174.44

Acrylic capped ABS stone resin 30% lighter than standard resin trays. Tray edge width 50mm.

All trays comply to BS EN14527:2006 Class 1/ BS EN15720:2009

Can be fitted flat to floor or with easy fit riser kit options. Suitable for marine ply boarded or concrete floor.

Integral anti-bacterial hygiene properties.

10 year guarantee

Slip Resistant Trays

Tray Type	Product Code	Size (mm)	Additional Information	Material	excl. VAT	incl. VAT
RECTANGULAR	ST810RW-SR	800 x 1000	Corner Waste	ABS stone	£245.25	£294.30
	ST712RW-SR	700 x 1200		ABS stone	£255.00	£306.00
	ST812RW-SR	800 x 1200		ABS stone	£283.50	£340.20
	ST912RW-SR	900 x 1200		ABS stone	£304.50	£365.40
	ST714RW-SR	700 x 1400		ABS stone	£408.00	£489.60
	ST814RW-SR	800 x 1400		ABS stone	£408.00	£489.60
	ST914RW-SR	900 x 1400		ABS stone	£429.75	£515.70
	ST815RW-SR	800 x 1500		ABS stone	£481.50	£577.80
	ST816RW-SR	800 x 1600		ABS stone	£537.75	£645.30
	ST817RW-SR	800 x 1700		Center (long side) Waste	ABS stone	£650.25
	ST917RW-SR	900 x 1700	ABS stone		£700.50	£840.60
SQUARE	ST80SW-SR	800 x 800	Corner Waste	ABS stone	£164.25	£197.10
	ST90SW-SR	900 x 900		ABS stone	£186.75	£224.10

Tray Waste

Colour	Product Code	Size (mm)	Additional Information	excl. VAT	incl. VAT
SILVER	STWASTE90C	90mm waste	Suitable for all 45mm Stone Resin trays	£32.50	£39.00
MATT BLACK	STWASTE90B	90mm waste		£40.83	£49.00
BRUSHED BRASS	STWASTE90BRS	90mm waste		£49.17	£59.00

Easy-Plumb Kits (suitable for use with all 50mm Stone Resin Trays)

The following riser systems are specifically designed to convert any of the 50mm trays to a raised installation. Includes height adjustable legs, panels and clips. 85mm installed height.

Tray Type	Product Code	Additional Information	excl. VAT	incl. VAT
SQUARE	STKIT1	Lakes Easy-Plumb Kit suits all square stone resin trays	£104.17	£125.00
RECTANGULAR UP TO 1200mm	STKIT2	Lakes Easy-Plumb Kit suits all rectangular stone resin trays up to 1200mm in size	£104.17	£125.00
RECTANGULAR ABOVE 1200mm	STKIT3	Lakes Easy-Plumb Kit suits all rectangular stone resin trays up to 1200mm x 900mm in size	£104.17	£125.00
QUADRANT	STKIT4	Lakes Easy-Plumb Kit suits all quadrant stone resin trays	£120.83	£145.00
OFFSET QUADRANT	STKIT5	Lakes Easy-Plumb Kit suits all offset quadrant stone resin trays	£120.83	£145.00

Acrylic capped ABS stone resin 30% lighter than standard resin trays. Tray edge width 50mm.

All trays comply to BS EN14527:2006 Class 1/ BS EN15720:2009

Surpasses the requirements of the Barefoot Ramp Test DIN 51097 for the best slip resistance

Can be fitted flat to floor or with easy fit riser kit options. Suitable for marine ply boarded or concrete floor.

Integral anti-bacterial hygiene properties.

Tray Heights

Low Profile: Edge height 50mm / Centre height 45mm

Wastes

Waste position is dependent on the type of tray selected. Complies with EN274-1.

Stone Resin Tray Waste Positions

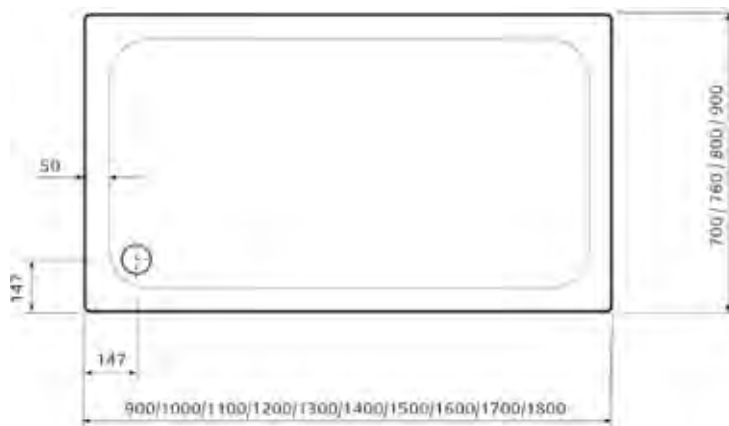
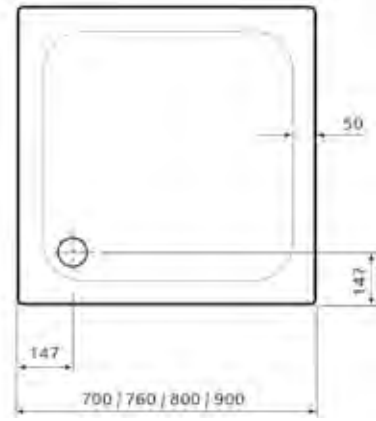
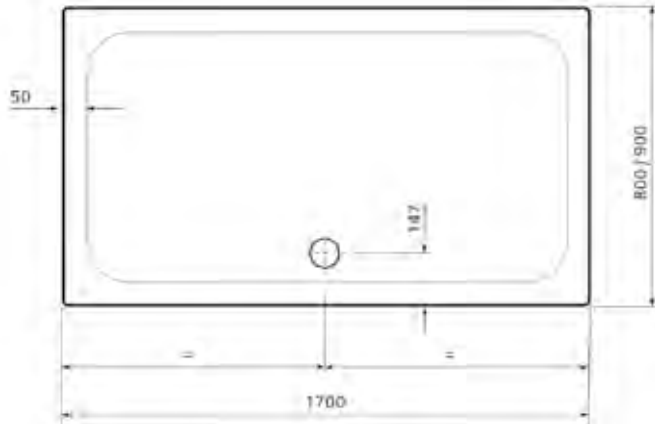

Modern Linear Style Shower Trays

Double Skinned Technology

Please note: There is an additional £10 delivery charge when ordering a single tray without an enclosure.

Tray Type	Product Code	Size (mm)	Material	excl. VAT	incl. VAT
SQUARE	TL9SW	900 x 900	ABS Stone	£287.16	£344.59
RECTANGULAR	TL128RW	800 x 1200	ABS Stone	£314.97	£377.96
	TL129RW	900 x 1200	ABS Stone	£330.48	£396.58
	TL148RW	800 x 1400	ABS Stone	£470.02	£564.02
	TL149RW	900 x 1400	ABS Stone	£489.98	£587.98
	TL158RW	800 x 1500	ABS Stone	£487.47	£584.96
	TL159RW	900 x 1500	ABS Stone	£507.39	£608.87
	TL168RW	800 x 1600	ABS Stone	£502.13	£602.56
	TL169RW	900 x 1600	ABS Stone	£521.83	£626.20
	TL178RW	800 x 1700	ABS Stone	£521.83	£626.20
	TL179RW	900 x 1700	ABS Stone	£541.49	£649.79

Tray Waste

Tray Type	Product Code	Size (mm)	Additional Information	excl. VAT	incl. VAT
LINEAR TRAYS	TLW	50mm waste	All Linear Trays (50mm ø waste)	£16.35	£19.62

BS EN 274. 39 ltr/min flow rate. 50mm depth water seal.

Required Tray Waste Cover

Product Code	Additional Information	excl. VAT	incl. VAT
TLW8W	Waste cover for 800mm trays	£85.15	£102.18
TLW9W	Waste cover for 900mm trays	£95.55	£114.66

Linear Tray Waste Positions

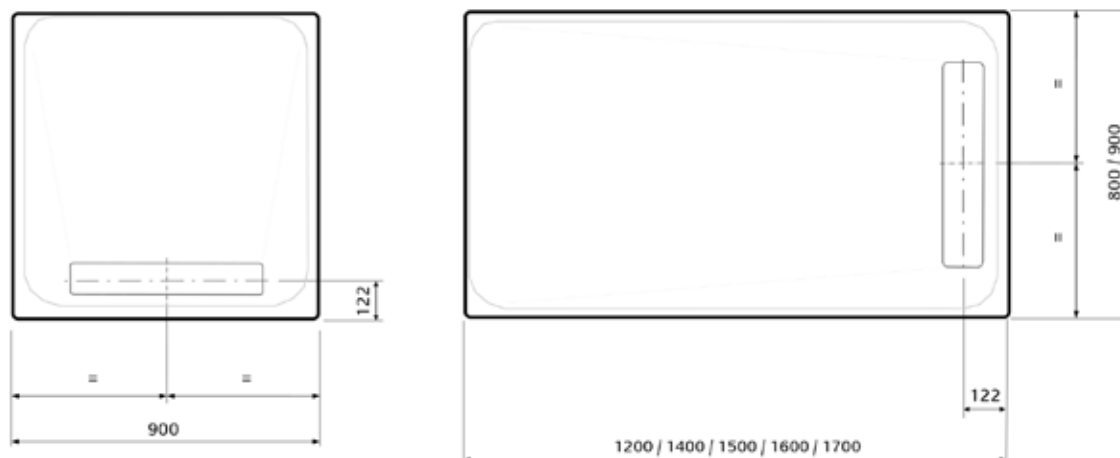

Acrylic capped ABS stone resin. 30% lighter than standard resin trays.

All trays comply to BS EN14527:2006 Class 1/BS EN15720:2009

Can be fitted flat to floor or with easy fit riser kit options. Suitable for marine ply boarded or concrete floor.

Integral anti-bacterial hygiene properties.

10 -year guarantee.

Tray Heights

Tray Profile: 33mm approx.

Wastes

Waste position is dependent on the type of tray selected. Complies with EN274-1.

Contact Lakes for advice.

In the detail

Quality is all about detail and whichever solution you choose, you'll find real attention has been paid to every aspect of design, function and finish.

Please note: All measurements are approximate and subject to change without prior notification. All product images are for illustration only and subject to change without prior notification.

Frames

Our elegant aluminium frames are available in three distinctive finishes. Choose from anodized polished silver, matt anodized black or a clean white powder coated finish, where available.

All our Collections, including doors and screen heights are measured from the top of the tray or bath.



Choose from anodized polished silver, matt black, Brushed Nickel, Brushed Brass, Brushed Bronze or Gun Metal coated finish where available.



Concealed fixings: Included on Island, Walk-In and Coastline Collections – all products except Alassio. Also included on SS100, SS105, SS120 and BSA bath screens.

Safety Glass

All our products are made from toughened glass, approved to BSI EN12150-1 in a range of thicknesses (see product pages).

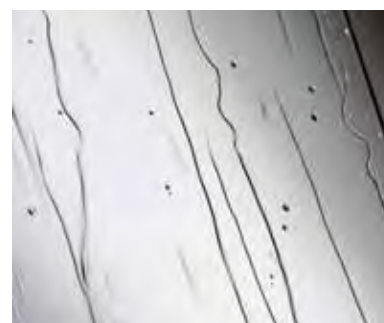

Toughened Safety Glass.

Handles

Our Lakes' branded handles are exclusive to the Island Collection (see pages 18-33) and Wave Collection (see pages 34-51). Smart and practical loop type handles in matching chrome plate or white powder coat are fitted to all Classic semi-framed products.



Die-cast Loop Handles (Coastline Collection).



Die cast handle with bright chrome plate for hinged door, Island Collection (see pages 18-33).



Stainless Steel with Bright Chrome Plate, bow handles (Wave Collection).



Reversibility

To match your room design the majority of our products, including doors and bath screens

are designed for universal fitting. However, please consult Lakes before ordering to ensure compatibility with site conditions.

Flexibility

Many of our Classic products can be made available in special heights and widths. For more details, please call Lakes.

Bearings

All our sliding door wheels are fitted with robust stainless steel bearings. The top wheels are adjustable to allow for fine tuning of door alignment. The bottom roller bearings feature 'Quick Release' buttons, spring loaded for easy cleaning.



Coastline Collection top wheel.

Adjustability

For the perfect finish, all our Collections have an adjustment for out of true walls built into each wall profile. The full range of tolerance is shown on each specification page.



Adjustable Wall Profiles.

Additional Strength

Bracing arms provide additional support, strength and safety for all double panel bath screens and our elegant Walk-In and Shower Screens.



Double Panel Bath Screen Bracing Arm.

Bath screen seals

Lakes bath screens come with high quality bottom seals. Over time and use this rubber can deteriorate and become less effective. Replacements can be purchased individually and easily fitted to your bath screen.



S104A - Universal bottom seal for 6mm bath screen hinged panel BSA10 - BSA60.

Optional Ceiling Bracing Kit

W10-040B: Available for Horizon Walk-In showers (pages 48-49).



Ceiling Bracing Kit W10-040B.

Extension Profiles

Our high quality extension profiles can be used to bridge gaps in non-standard sized openings (detailed on relevant product pages).

860-N - Aluminium Extension Profile for Antigua and Aruba, Island Collection.

Can be fitted to FIXED PANEL SIDE only of slider door and to side panel on the Aruba.

LK8LEPS - Aluminium Extension Profile for the Island hinged door.

LK8LEPB - black variant for Wave Walk In products.

8HLEPS - Aluminium Extension Profile for the Coastline Doors (8H) Collection.

LEPS (silver) or LEPW (white) - Aluminium Extension Profile for the Classic Range.

WAVLEPS (silver), WAVLEPB (matt black) & WAVLEPBR (brushed brass) - aluminium Extension Profile for Wave shower doors.





Lakes Additions

Our products are designed with modern family life in mind, reflecting changing demographic trends such as the rise in multi-generational living. Bathrooms that cater for different needs within the same household are increasingly important, with style, accessibility, robustness and low-maintenance all high priorities.

Lakes Additions is a growing suite of additional options for showering spaces to suit your life and style. Whether it's adding a removable handle or a discreet foldaway seat, this versatile range means everyone in the home can enjoy an invigorating shower without compromising on comfort or design.



Shower seats



SERIES 500 SD
Available in chrome/grey or chrome/white. See page 151 for Series 500 folding handle



SERIES 500 SD
Available in chrome/grey or chrome/white



SERIES 300 SD
Available in chrome/grey, chrome/white or white



SERIES 200 RD
Fixings available in white, gold or chrome



SERIES 200 SD
Fixings available in white, gold or chrome



SERIES 150 RD
Available in chrome/grey or chrome/white



ANIMO RD
Available in white



Grab Bars and Rails

SERIES 500 HOLDING HANDLE



SERIES 500 HOLDING HANDLE 90° WITH SHOWER HOLDER

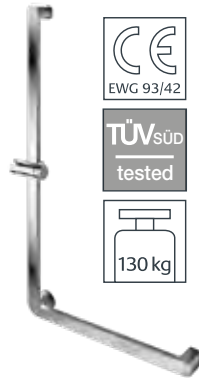

SERIES 500 WALL HANDRAIL

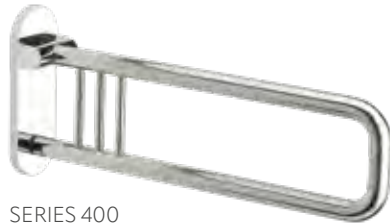

SERIES 400 FOLDING SUPPORT HANDLE



Also in chrome



SERIES 400 HANDRAIL



Also in chrome

SERIES 150 HANDRAIL

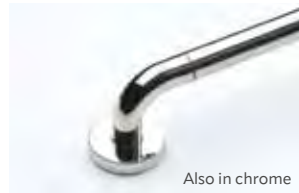

Also in chrome

SERIES 500 FOLDING HANDLE WITH UNHOOK MECHANISM



SERIES 500 FOLDING HANDLE WITH SOFT SURFACE, WITH UNHOOK MECHANISM

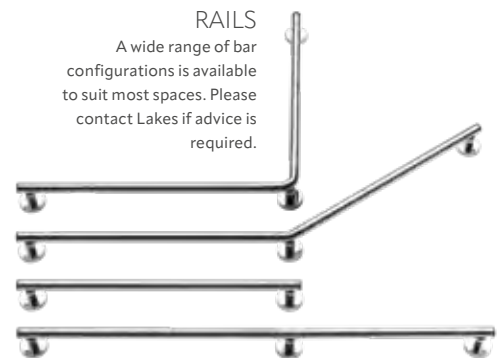



RAILS

A wide range of bar configurations is available to suit most spaces. Please contact Lakes if advice is required.

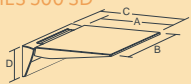
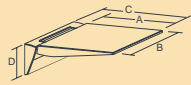

Shower Seats

All dimensions are in mm

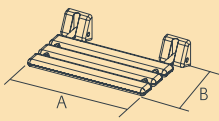
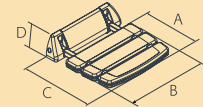
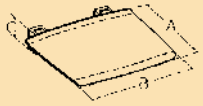
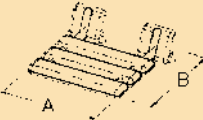
Product	Description	Code	Fixings colour	A	B	C	D	excl. VAT	incl. VAT
SERIES 500 SD 	Shower seat	5040SD05PM	Chrome/Grey	400	400	450	115	£609.37	£731.24
		5040SD69PM	Chrome/White	400	400	450	115	£592.67	£711.21
SERIES 500 SD 	Shower seat	5035SD05PM	Chrome/Grey	320	355	370	115	£428.51	£512.21
		5035SD69PM	Chrome/White	320	355	370	115	£411.81	£494.17
SERIES 300 SD 	Shower seat	3020SD31PM	White	330	355	370	105	£228.17	£273.80
		3020SD69PM	Chrome/White	330	355	370	105	£265.73	£318.87
		3020SD05PM	Chrome/Grey	330	355	370	105	£265.73	£318.87
SERIES 200 RD 	Shower seat in Iroko hardwood	002RD31PM	White	489	330	N/A	N/A	£392.33	£470.80
		002RD03PM	Gold	489	330	N/A	N/A	£577.37	£692.84
		002RD05PM	Chrome	489	330	N/A	N/A	£446.59	£535.91
SERIES 200 SD 	Shower seat	0020SD31PM	White	240	350	337	105	£193.38	£232.06
		0020SD29PM	White/Gold	240	350	337	105	£203.12	£243.75
		0020SD69PM	White/Chrome	240	350	337	105	£187.82	£225.38
SERIES 150 RD 	Shower seat	0015RD05	Chrome/grey	325	325	60	N/A	£200.34	£240.41
		0015RD69	Chrome/white	325	325	60	N/A	£193.38	£232.06
ANIMO RD 	Shower seat	0001RD31PE	White	320	320	N/A	N/A	£134.95	£161.94

Rails

All dimensions are in mm

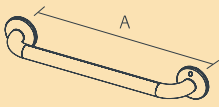
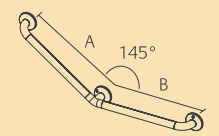
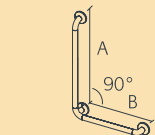
Product	Description	Code	Colour	A	B	excl. VAT	incl. VAT
SERIES 150 STEEL SG 	Holding handle	3001SG05	Chrome	250	N/A	£175.30	£210.36
		3002SG05	Chrome	450	N/A	£187.82	£225.38
		3003SG05	Chrome	550	N/A	£193.38	£232.06
		3004SG05	Chrome	650	N/A	£200.34	£240.41
	Wall handle 145° reversible	3010SG05	Chrome	580	480	£311.64	£373.97
		3011SG05	Chrome	680	480	£329.73	£395.67
		3012SG05	Chrome	680	580	£345.03	£414.04
	Wall handle 90° reversible	3015SG05	Chrome	600	450	£311.64	£373.97
		3016SG05	Chrome	700	450	£329.73	£395.67
		3017SG05	Chrome	700	550	£345.03	£414.04

Grab Bars & Rails

All dimensions are in mm

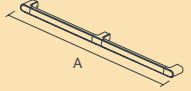
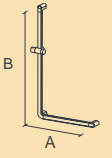
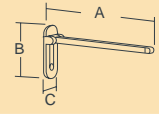
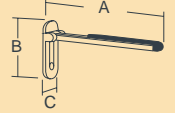
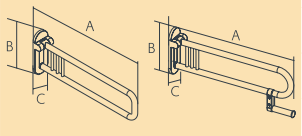
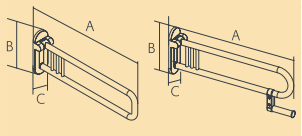
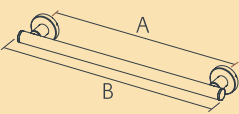
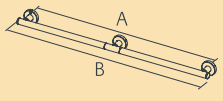
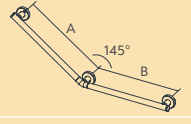
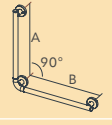
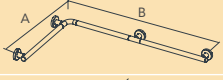
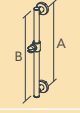
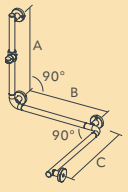
Product	Description	Code	Colour	A	B	C	excl. VAT	incl. VAT
SERIES 500 SG								
	Holding handle	5020SG05PM	Chrome	300	N/A	N/A	£165.56	£198.67
		5021SG05PM	Chrome	400	N/A	N/A	£201.73	£242.08
		5022SG05PM	Chrome	500	N/A	N/A	£210.08	£252.08
		5023SG05PM	Chrome	600	N/A	N/A	£221.21	£265.45
	Wall handrail	5030SG05PM	Chrome	1050	N/A	N/A	£367.29	£440.75
		5032SG05PM	Chrome	1250	N/A	N/A	£400.68	£480.82
	Holding handle 90° with shower holder	5102SG05PM	Chrome	700	1200	N/A	£557.89	£669.47
	Folding handle with unhook mechanism	5401SG05PM	Chrome	650	280	100	£578.76	£694.51
	Folding handle with soft surface, with unhook mechanism	5601SG05PM	Chrome	650	280	100	£653.89	£784.67
SERIES 400 STEEL SG								
	Folding support handle (also available as fixed)	4045SG05PM	Chrome	650	280	100	£598.24	£717.89
		4046SG05PM	Chrome	750	280	100	£621.89	£746.27
	Folding support handle with toilet roll holder	4245SG05PM	Chrome	650	280	100	£671.97	£806.37
		4246SG05PM	Chrome	750	280	100	£698.41	£838.09
	Holding handle	4001SG05PM	Chrome	250	330	N/A	£175.30	£210.36
		4002SG05PM	Chrome	450	530	N/A	£187.82	£225.38
		4003SG05PM	Chrome	550	630	N/A	£193.38	£232.06
		4004SG05PM	Chrome	650	730	N/A	£200.34	£240.41
	Wall handrail	4005SG05PM	Chrome	1050	1130	N/A	£311.64	£373.97
		4006SG05PM	Chrome	1150	1230	N/A	£329.73	£395.67
		4007SG05PM	Chrome	1250	1330	N/A	£345.03	£414.04
	Wall handle 145° reversible	4010SG05PM	Chrome	580	480	N/A	£311.64	£373.97
		4011SG05PM	Chrome	680	480	N/A	£329.73	£395.67
		4012SG05PM	Chrome	680	580	N/A	£345.03	£414.04
	Wall handle 90° reversible	4015SG05PM	Chrome	600	450	N/A	£311.64	£373.97
		4016SG05PM	Chrome	700	450	N/A	£329.73	£395.67
		4017SG05PM	Chrome	700	550	N/A	£345.03	£414.04
	Double shower handrail	4030SG05PM	Chrome	660	1125	N/A	£435.46	£522.55
		4031SG05PM	Chrome	760	1125	N/A	£446.59	£535.91
	Holding handle with shower holder	4050SG05PM	Chrome	800	880	N/A	£278.25	£333.90
		4051SG05PM	Chrome	1000	1080	N/A	£303.29	£363.95
	Wall handrail with shower holder	4060SG05PM	Chrome	800	560	525	£523.11	£627.73
		4061SG05PM	Chrome	1000	560	525	£539.81	£647.77
		4062SG05PM	Chrome	1000	560	775	£563.46	£676.15
		4064SG05PM	Chrome	1200	560	775	£610.76	£732.91

Product Care

Caring for your shower door walk in panels, shower, bath screen and shower tray

To maintain your guarantee, we recommend cleaning as below:

- Glass: Only use a soft cloth and mild detergent, rinse off thoroughly after cleaning.
- Metal and metallic surfaces: Use only a soft cloth and warm soapy water. Rinse off thoroughly.
- In hard water areas, regular cleaning of your Lakes product will help to prevent the build-up of limescale.
- Limescale can be removed using a 50:50 solution of white vinegar and water.
- Check your shower door for functionality periodically. Ensure that the wheel track is free from any grit/dirt which may have collected over time.
- Do not use "Spray & leave" cleaning products on the metal surface as these will cause damage to your product.
- Do NOT use cleaning products, bleaches, solvents or abrasive pads.
- Non-compliance with these cleaning instructions will invalidate the products guarantee and may cause plated / painted / anodised surfaces/finishes to deteriorate and could adversely affect safe operation of the enclosure.

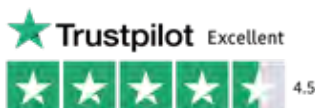
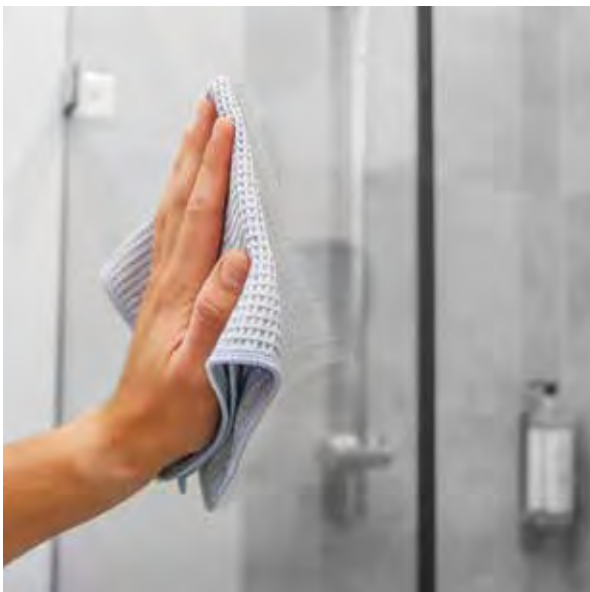

After Sales Commitment

At Lakes we are passionately devoted to providing the very best customer service. Lakes excellent customer service is supported by an extensive stock of spare parts across all ranges..

Call our dedicated customer service team on **01684 853870** who will deal with your enquiry and will swiftly dispatch your spares order. Alternatively email customerservice@lakesuk.com or head to our website and complete our enquiry form www.lakesuk.com/contact-us

Spare Parts

We have a team of technical experts who can deal with and offer advice on any queries you may have and arrange despatch of spare parts within 3-5 working days. Call us on **01684 853870**.

What to do if something goes wrong

Should the product not function correctly on initial use, firstly, contact the installer to check the installation is in accordance with your installation instructions. Should this not resolve difficulties or should performance decline, refer to the 'Troubleshooting' section within the installation guide. Alternatively, our customer service team can assist or if necessary, arrange for a service engineer to visit. Please call **01684 853870**, email customerservice@lakesuk.com or head to our website and complete our enquiry form: www.lakesuk.com/contact-us

Returns Policy

Lakes will not accept return of any product no longer required that has been opened. We do not accept return of any product if the packaging has been damaged. If the product is unopened and not damaged, we will accept the return subject to agreed returns charges, but no longer than 3 months from date of original delivery.

As part of Lakes continuing policy of product improvement, we reserve the right to amend specifications, colours and prices and discontinue products without prior notice.

Images, room layouts and associated bathroom products are for marketing and visual purposes only. The colours and finishes shown in the catalogues are as accurate the printing process permits.

*Errors and Omissions Exempt.

Plan your bathroom

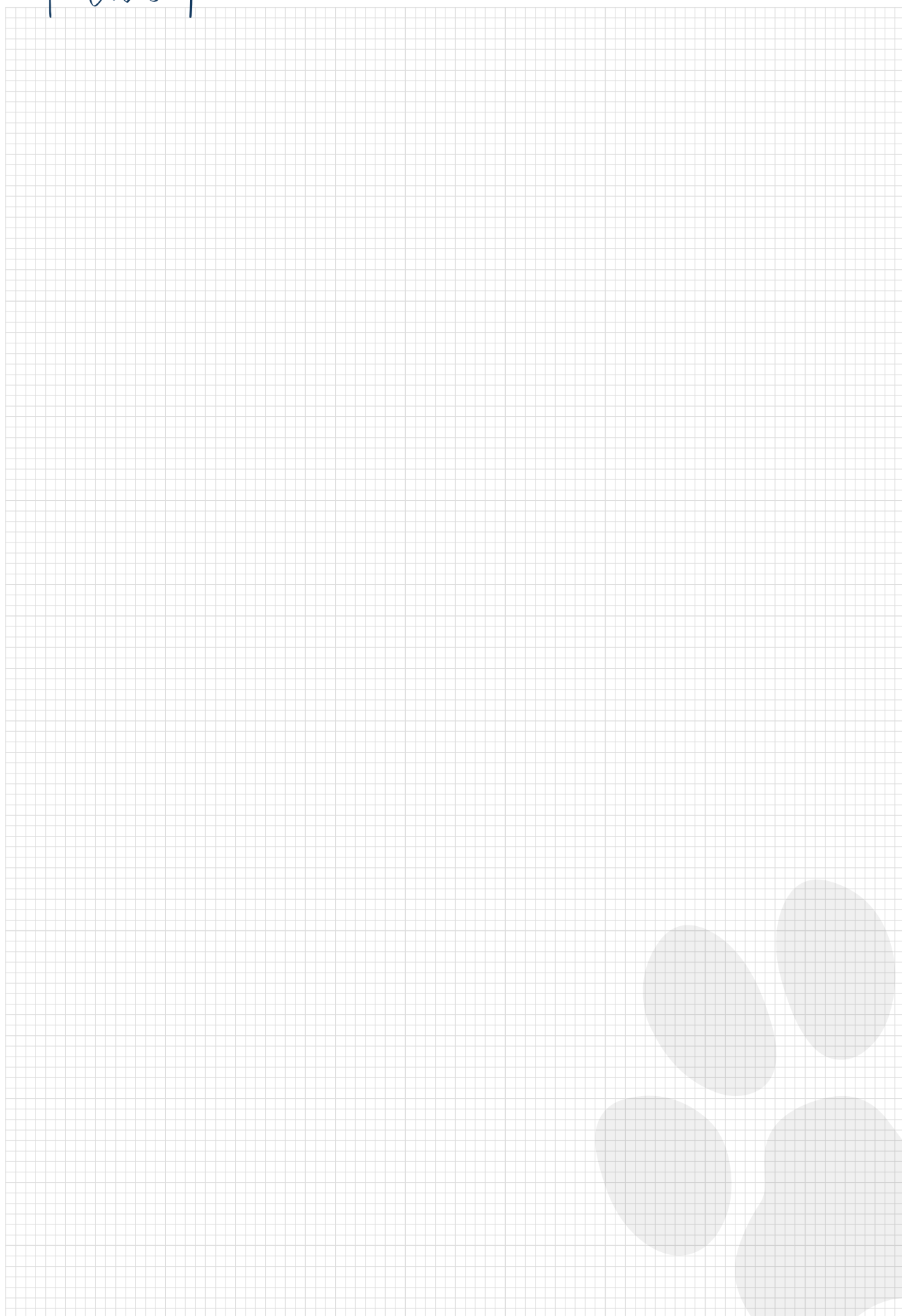

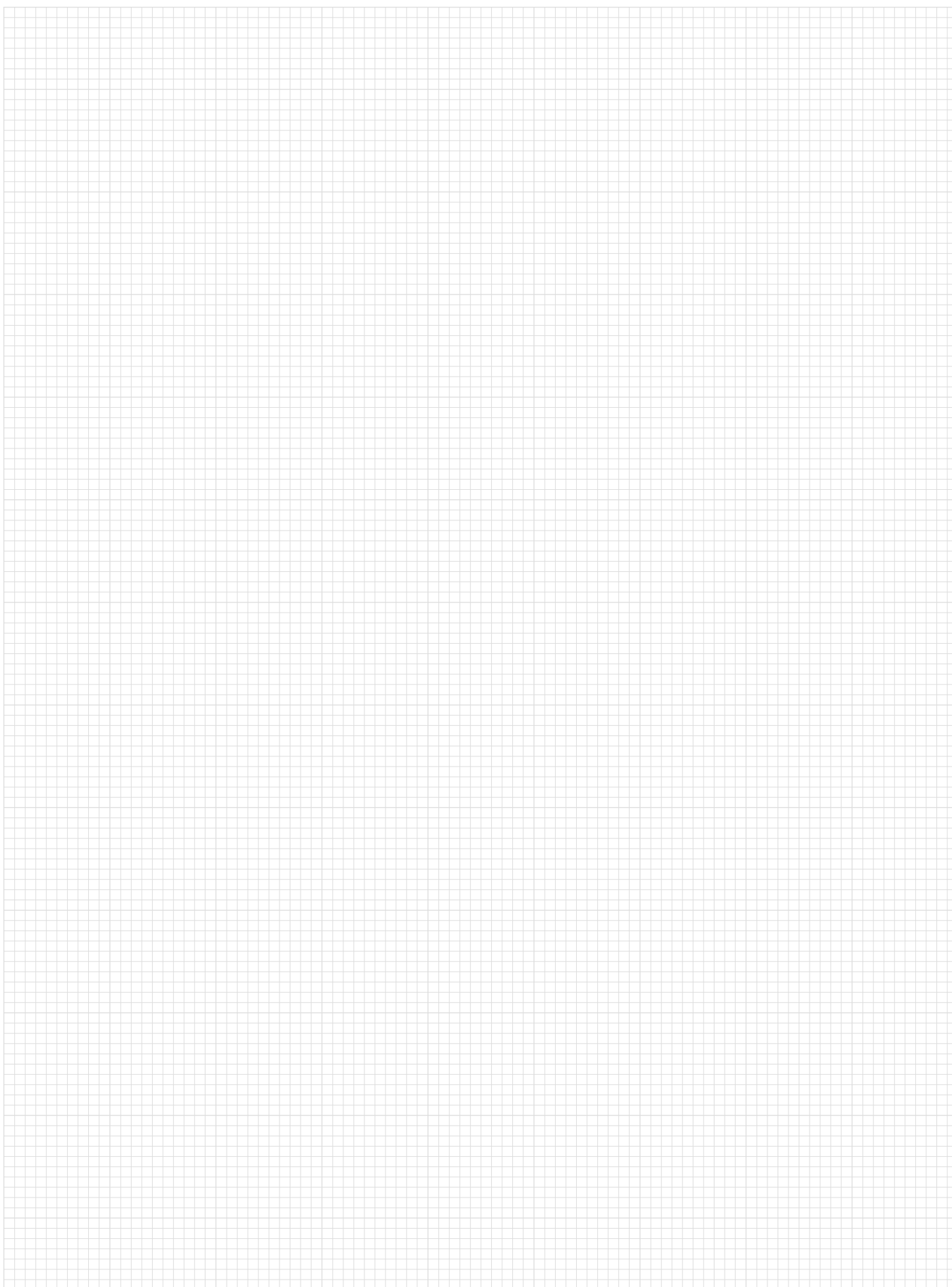



LAKES
SHOWERING SPACES

Lakes

Alexandra Way
Ashchurch
Tewkesbury
Gloucestershire GL20 8NB

Tel: 01684 853870
Fax: 01684 857411
Enquiries: info@lakesuk.com

lakeshoweringspaces.com

Issue date: Summer 25
Stock code: BRLKS-36
© Lakes Bathrooms Limited 2024

[@LakesForLife](https://twitter.com/LakesForLife) 

